

---

CT404

---

Graphics & Image Processing

---



---

Name: Andrew Hayes  
Student ID: 21321503  
E-mail: a.hayes18@universityofgalway.ie

---

2024-11-07

# Contents

<b>1</b>	<b>Introduction</b>	<b>1</b>
1.1	Grading . . . . .	1
1.1.1	Reflection on Exams . . . . .	1
1.2	Lecturer Contact Information . . . . .	1
<b>2</b>	<b>Introduction to 2D Graphics</b>	<b>1</b>
2.1	Digital Images – Bitmaps . . . . .	1
2.2	Colour Encoding Schemes . . . . .	1
2.3	The Real-Time Graphics Pipeline . . . . .	2
2.4	Graphics Software . . . . .	2
2.5	Graphics Formats . . . . .	2
<b>3</b>	<b>2D Vector Graphics</b>	<b>2</b>
3.1	Transformations . . . . .	3
3.1.1	2D Translation . . . . .	3
3.1.2	2D Rotation of a <i>Point</i> . . . . .	3
3.1.3	2D Rotation of an <i>Object</i> . . . . .	4
3.1.4	Arbitrary 2D Rotation . . . . .	4
3.1.5	Matrix Notation . . . . .	4
3.1.6	Scaling . . . . .	5
3.1.7	Order of Transformations . . . . .	5
<b>4</b>	<b>2D Raster Graphics</b>	<b>5</b>
4.1	Introduction to HTML5/Canvas . . . . .	5
4.1.1	Canvas: Rendering Contexts . . . . .	5
4.1.2	Canvas2D: Primitives . . . . .	6
4.1.3	Canvas2D: <code>drawImage()</code> . . . . .	7
4.1.4	Canvas2D: Fill & Stroke Colours . . . . .	7
4.1.5	Canvas2D: Translations . . . . .	8
4.1.6	Canvas2D: Order of Transformations . . . . .	9
4.1.7	Scaling . . . . .	10
4.1.8	Canvas2D: Programmatic Graphics . . . . .	10
<b>5</b>	<b>3D Co-Ordinate Systems</b>	<b>11</b>
5.1	Nested Co-Ordinate Systems . . . . .	11
5.2	3D Transformations . . . . .	11
5.2.1	Translation . . . . .	11
5.2.2	Rotation About Principal Axes . . . . .	11
5.2.3	Rotation About Arbitrary Axes . . . . .	12
<b>6</b>	<b>Graphics APIs</b>	<b>12</b>
6.1	Three.js . . . . .	12
6.1.1	3D Primitives . . . . .	13
6.1.2	Cameras . . . . .	15
6.1.3	Lighting . . . . .	15
6.1.4	Nested Co-Ordinates . . . . .	17
6.1.5	Geometry Beyond Primitives . . . . .	19

<b>7</b>	<b>Animation &amp; Interactivity</b>	<b>19</b>
7.1	Handling the Keyboard . . . . .	19
7.2	Mouse Handling . . . . .	19
7.3	Time-Based Animation . . . . .	19
7.4	Raycasting . . . . .	19
7.5	Shading Algorithms . . . . .	19
7.5.1	Flat Shading . . . . .	20
7.5.2	Smooth (Gourard) Shading . . . . .	20
7.5.3	Normal Interpolating (Phong) Shading . . . . .	21
7.6	Shading in Three.js . . . . .	21
7.7	Shadows in Three.js . . . . .	21
7.8	Reflectivity of Materials in Three.js . . . . .	21
<b>8</b>	<b>Image Processing</b>	<b>22</b>
8.1	Introduction to OpenCV . . . . .	22
8.2	Point Transformations . . . . .	22
8.2.1	Histogram Manipulation . . . . .	22
8.2.2	Thresholding . . . . .	24
8.3	Geometric Transformations . . . . .	25
8.3.1	Interpolation . . . . .	25
8.3.2	Warping . . . . .	25
8.3.3	Image Rectification . . . . .	26
8.3.4	Image Registration . . . . .	26
8.3.5	Map Projection . . . . .	26
8.3.6	Image Morphing . . . . .	27
<b>9</b>	<b>Spatial Filtering</b>	<b>28</b>
9.1	Image Filtering for Noise Reduction . . . . .	28
9.2	Image Filtering for Edge Detection . . . . .	29
9.2.1	First Order Derivatives . . . . .	29
9.2.2	Second Order Derivatives . . . . .	32
9.3	Image Filtering in the Frequency Domain . . . . .	33
<b>10</b>	<b>Morphological Image Processing</b>	<b>33</b>
10.1	Basic Morphological Operations . . . . .	34
10.2	Connected Components . . . . .	37
10.3	Distance Transform . . . . .	37
10.4	Skeletonisation . . . . .	38
10.5	Region Properties . . . . .	39
<b>11</b>	<b>Edge &amp; Feature Detection</b>	<b>41</b>
11.1	Multiresolution Processing . . . . .	41
11.2	Edge Detection . . . . .	43
11.3	Feature Detection . . . . .	44
11.4	Feature Descriptors . . . . .	45
<b>12</b>	<b>Segmentation &amp; Model Fitting</b>	<b>45</b>

# 1 Introduction

Textbooks:

- Main textbook: *Image Processing and Analysis* – Stan Birchfield (ISBN: 978-1285179520).
- *Introduction to Computer Graphics* – David J. Eck. (Available online at <https://math.hws.edu/graphicsbook/>).
- *Computer Graphics: Principles and Practice* – John F. Hughes et al. (ISBN: 0-321-39952-8).
- *Computer Vision: Algorithms and Applications* – Richard Szeliski (ISBN: 978-3-030-34371-2).

**Computer graphics** is the processing & displaying of images of objects that exist conceptually rather than physically with emphasis on the generation of an image from a model of the objects, illumination, etc. and the real-time rendering of images. Ideas from 2D graphics extend to 3D graphics.

**Digital Image processing/analysis** is the processing & display of images of real objects, with an emphasis on the modification and/or analysis of the image in order to automatically or semi-automatically extract useful information. Image processing leads to more advanced feature extraction & pattern recognition techniques for image analysis & understanding.

## 1.1 Grading

- Assignments: 30%.
- Final Exam: 70%.

### 1.1.1 Reflection on Exams

“A lot of people give far too little detail in these questions, and/or don’t address the discussion parts – they just give some high-level definitions and consider it done – which isn’t enough for final year undergrad, and isn’t answering the question. More is expected in answers than just repeating what’s in my slides. The top performers demonstrate a higher level of understanding and synthesis as well as more detail about techniques and discussion of what they do on a technical level and how they fit together”

## 1.2 Lecturer Contact Information

- |  |  |
|--|--|
| • Dr. Nazre Batool.  | • Dr. Waqar Shahid Qureshi.  |
| • <a href="mailto:nazre.batool@universityofgalway.ie">nazre.batool@universityofgalway.ie</a> | • <a href="mailto:waqarshahid.qureshi@universityofgalway.ie">waqarshahid.qureshi@universityofgalway.ie</a> . |
| • Office Hours: Thursdays 16:00 – 17:00, CSB-2009.   | • Office Hours: Thursdays 16:00 – 17:00, CSB-3001.   |

# 2 Introduction to 2D Graphics

## 2.1 Digital Images – Bitmaps

**Bitmaps** are grid-based arrays of colour or brightness (greyscale) information. **Pixels** (*picture elements*) are the cells of a bitmap. The **depth** of a bitmap is the number of bits-per-pixel (bpp).

## 2.2 Colour Encoding Schemes

Colour is most commonly represented using the **RGB (Red, Green, Blue)** scheme, typically using 24-bit colour with one 8-bit number representing the level of each colour channel in that pixel.

Alternatively, images can also be represented in **greyscale** wherein pixels are represented with one (typically 8-bit) brightness value (or scale of grey) .

### 2.3 The Real-Time Graphics Pipeline

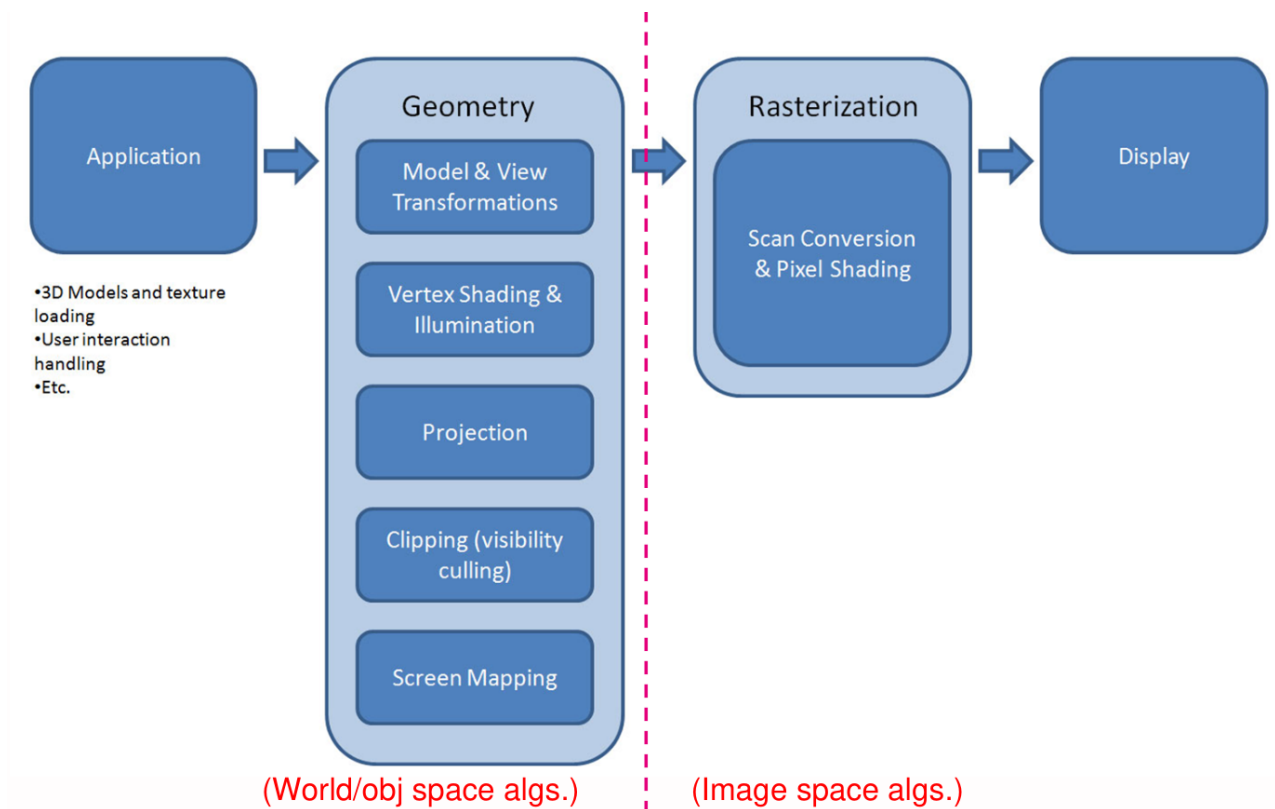

Figure 1: The Real-Time Graphics Pipeline

### 2.4 Graphics Software

The **Graphics Processing Unit (GPU)** of a computer is a hardware unit designed for digital image processing & to accelerate computer graphics that is included in modern computers to complement the CPU. They have internal, rapid-access GPU memory and parallel processors for vertices & fragments to speed up graphics renderings.

**OpenGL** is a 2D & 3D graphics API that has existed since 1992 that is supported by the graphics hardware in most computing devices today. **WebGL** is a web-based implementation of OpenGL for use within web browsers. OpenGL ES for Embedded Systems such as tablets & mobile phones also exists.

OpenGL was originally a client/server system with the CPU+Application acting as a client sending commands & data to the GPU acting as a server. This was later replaced by a programmable graphics interface (OpenGL 3.0) to write GPU programs (shaders) to be run by the GPU directly. It is being replaced by newer APIs such as Vulkan, Metal, & Direct3D and WebGL is being replaced by WebGPU.

### 2.5 Graphics Formats

**Vector graphics** are images described in terms of co-ordinate drawing operations, e.g. AutoCAD, PowerPoint, Flash, SVG. **SVG (Scalable Vector Graphics)** is an image specified by vectors which are scalable without losing any quality.

**Raster graphics** are images described as pixel-based bitmaps. File formats such as GIF, PNG, JPEG represent the image by storing colour values for each pixel.

## 3 2D Vector Graphics

**2D vector graphics** describe drawings as a series of instructions related to a 2-dimensional co-ordinate system. Any point in this co-ordinate system can be specified using two numbers  $(x, y)$ :

- The horizontal component  $x$ , measuring the distance from the left-hand edge of the screen or window.
- The vertical component  $y$ , measuring the distance from the bottom of the screen or window (or sometimes from the top).

### 3.1 Transformations

#### 3.1.1 2D Translation

The **translation** of a point in 2 dimensions is the movement of a point  $(x, y)$  to some other point  $(x', y')$ .

$$x' = x + a$$

$$y' = y + b$$

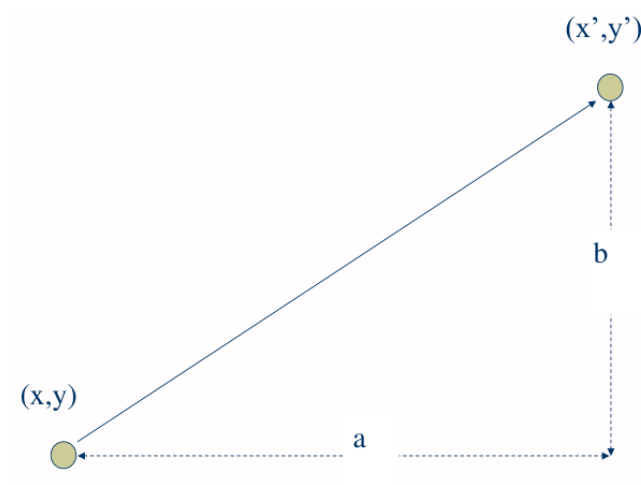

Figure 2: 2D Translation of a Point

#### 3.1.2 2D Rotation of a Point

The simplest rotation of a point around the origin is given by:

$$x' = x \cos \theta - y \sin \theta$$

$$y' = x \sin \theta + y \cos \theta$$

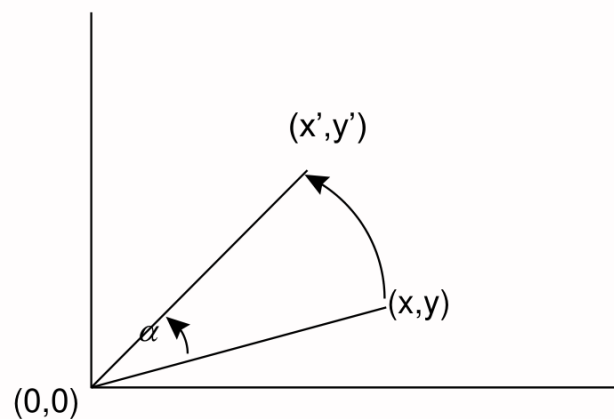

Figure 3: 2D Rotation of a Point

### 3.1.3 2D Rotation of an Object

In vector graphics, **objects** are defined as series of drawing operations (e.g., straight lines) performed on a set of vertices. To rotate a line or more complex object, we simply apply the equations to rotate a point to the  $(x, y)$  co-ordinates of each vertex.

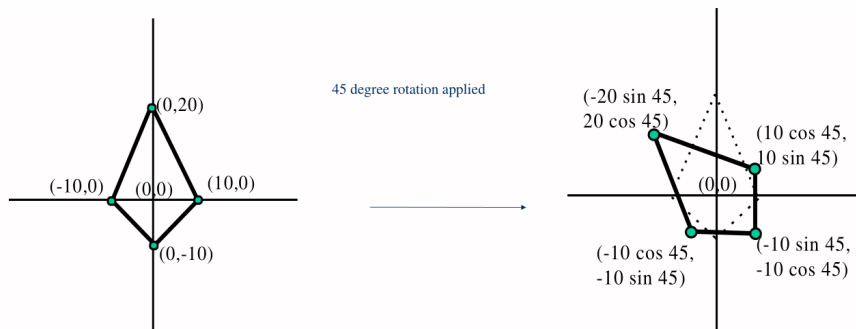

Figure 4: 2D Rotation of an Object

### 3.1.4 Arbitrary 2D Rotation

In order to rotate around an arbitrary point  $(a, b)$ , we perform translation, then rotation, then reverse the translation.

$$x' = a + (x - a) \cos \theta - (y - b) \sin \theta$$

$$y' = a + (x - a) \sin \theta + (y - b) \cos \theta$$

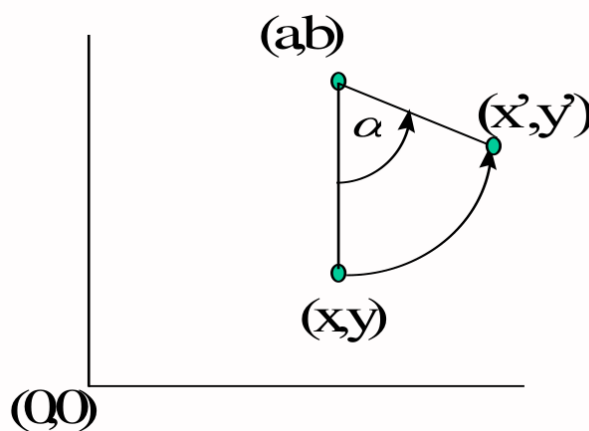

Figure 5: Arbitrary 2D Rotation

### 3.1.5 Matrix Notation

**Matrix notation** is commonly used for vector graphics as more complex operations are often easier in matrix format and because several operations can be combined easily into one matrix using matrix algebra.

Rotation about  $(0, 0)$ :

$$\begin{bmatrix} x' & y' \end{bmatrix} = \begin{bmatrix} x & y \end{bmatrix} \begin{bmatrix} \cos \theta & \sin \theta \\ -\sin \theta & \cos \theta \end{bmatrix}$$

Translation:

$$\begin{bmatrix} x' & y' & 1 \end{bmatrix} = \begin{bmatrix} x & y & 1 \end{bmatrix} \begin{bmatrix} 1 & 0 & 0 \\ 0 & 1 & 0 \\ a & 0 & 1 \end{bmatrix}$$

### 3.1.6 Scaling

**Scaling** of an object is achieved by considering each of its vertices in turn, multiplying said vertex's  $x$  &  $y$  values by the scaling factor. A scaling factor of 2 will double the size of the object, while a scaling factor of 0.5 will halve it. It is possible to have different scaling factors for  $x$  &  $y$ , resulting in a **stretch**:

$$x' = x \times s$$

$$y' = y \times t$$

If the object is not centred on the origin, then scaling it will also effect a translation.

### 3.1.7 Order of Transformations

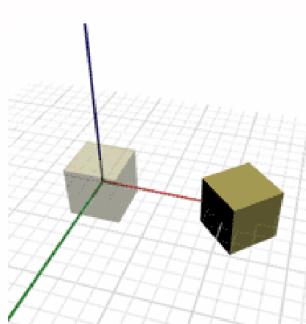

- ◆ Translation 2 units along the red axis
- ◆ Then Rotation by 45 degrees around the (new) centre

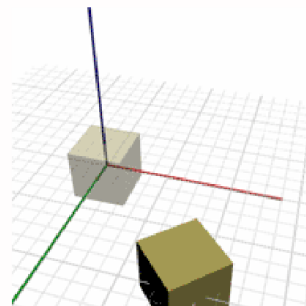

- ◆ Rotation by 45 degrees
- ◆ Then Translation 2 units along the (rotated) red axis

Figure 6: Order of Transformations

## 4 2D Raster Graphics

The raster approach to 2D graphics considers digital images to be grid-based arrays of pixels and operates on the images at the pixel level.

### 4.1 Introduction to HTML5/Canvas

**HTML** or HyperText Markup Language is a page-description language used primarily for website. **HTML5** brings major updates & improvements to the power of client-side web development.

A **canvas** is a 2D raster graphics component in HTML5. There is also a **canvas with 3D** (WebGL) which is a 3D graphics component that is more likely to be hardware-accelerated but is also more complex.

#### 4.1.1 Canvas: Rendering Contexts

`<canvas>` creates a fixed-size drawing surface that exposes one or more **rendering contexts**. The `getContext()` method returns an object with tools (methods) for drawing.

```

1 <html>
2   <head>
3     <script>
4       function draw() {
5         var canvas = document.getElementById("canvas");
6         var ctx = canvas.getContext("2d");

```



```

7         ctx.fillStyle = "rgb(200,0,0)";
8         ctx.fillRect (10, 10, 55, 50);
9         ctx.fillStyle = "rgba(0, 0, 200, 0.5)";
10        ctx.fillRect (30, 30, 55, 50);
11    }
12    </script>
13 </head>
14 <body onload="draw();">
15     <canvas id="canvas" width="150" height="150"></canvas>
16 </body>
17 </html>

```



Figure 7: Rendering of the Above HTML Code

#### 4.1.2 Canvas2D: Primitives

Canvas2D only supports one primitive shape: rectangles. All other shapes must be created by combining one or more *paths*. Fortunately, there are a collection of path-drawing functions which make it possible to compose complex shapes.

```

1  function draw(){
2      var canvas = document.getElementById('canvas');
3      var ctx = canvas.getContext('2d');
4      ctx.fillRect(125,25,100,100);
5      ctx.clearRect(145,45,60,60);
6      ctx.strokeRect(150,50,50,50);
7      ctx.beginPath();
8      ctx.arc(75,75,50,0,Math.PI*2,true); // Outer circle
9      ctx.moveTo(110,75);
10     ctx.arc(75,75,35,0,Math.PI,false); // Mouth (clockwise)
11     ctx.moveTo(65,65);
12     ctx.arc(60,65,5,0,Math.PI*2,true); // Left eye
13     ctx.moveTo(95,65);
14     ctx.arc(90,65,5,0,Math.PI*2,true); // Right eye
15     ctx.stroke(); // renders the Path that has been built up..
16 }

```



Figure 8: Rendering of the Above JavaScript Code

### 4.1.3 Canvas2D: drawImage()

The example below uses an external image as the backdrop of a small line graph:

```

1  function draw() {
2      var ctx = document.getElementById('canvas').getContext('2d');
3      var img = new Image();
4      img.src = 'backdrop.png';
5      img.onload = function() {
6          ctx.drawImage(img,0,0);
7          ctx.beginPath();
8          ctx.moveTo(30,96);
9          ctx.lineTo(70,66);
10         ctx.lineTo(103,76);
11         ctx.lineTo(170,15);
12         ctx.stroke();
13     }
14 }
```

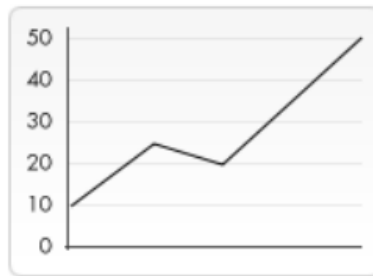

Figure 9: Rendering of the Above JavaScript Code

### 4.1.4 Canvas2D: Fill & Stroke Colours

```

1  <html>
2      <head>
3          <script>
4              function draw() {
5                  var canvas = document.getElementById("canvas");
6                  var context = canvas.getContext('2d');
7                  // Filled Star
8                  context.lineWidth=3;
9                  context.fillStyle="#CC00FF";
10                 context.strokeStyle="#ffff00"; // NOT lineWidth!
11                 context.beginPath();
12                 context.moveTo(100,50);
13                 context.lineTo(175,200);
14                 context.lineTo(0,100);
15                 context.lineTo(200,100);
16                 context.lineTo(25,200);
17                 context.lineTo(100,50);
18                 context.fill(); // colour the interior
19                 context.stroke(); // draw the lines
20             }
21     </script>
```

```

22 </head>
23 <body onload="draw();">
24   <canvas id="canvas" width="300" height="300"></canvas>
25 </body>
26 </html>

```

Colours can be specified by name (red), by a string of the form `rgb(r,g,b)`, or by hexadecimal colour codes `#RRGGBB`.



Figure 10: Rendering of the Above JavaScript Code

#### 4.1.5 Canvas2D: Translations

```

1 <html>
2   <head>
3     <script>
4       function draw() {
5         var canvas = document.getElementById("canvas");
6         var context = canvas.getContext('2d');
7         context.save(); // save the default (root) co-ord system
8         context.fillStyle="#CC00FF"; // purple
9         context.fillRect(100,0,100,100);
10        // translates from the origin, producing a nested co-ordinate system
11        context.translate(75,50);
12        context.fillStyle="#FFFF00"; // yellow
13        context.fillRect(100,0,100,100);
14        // transforms further, to produce another nested co-ordinate system
15        context.translate(75,50);
16        context.fillStyle="#0000FF"; // blue
17        context.fillRect(100,0,100,100);
18        context.restore(); // recover the default (root) co-ordinate system
19        context.translate(-75,90);
20        context.fillStyle="#00FF00"; // green
21        context.fillRect(100,0,100,100);
22      }
23    </script>
24  </head>
25  <body onload="draw();">
26    <canvas id="canvas" width="600" height="600"></canvas>
27  </body>
28 </html>

```

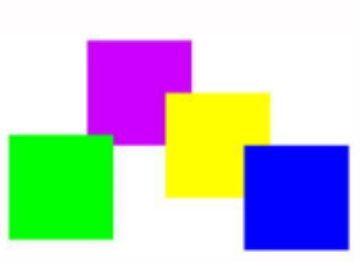

Figure 11: Rendering of the Above JavaScript Code

#### 4.1.6 Canvas2D: Order of Transformations

```

1 <html>
2   <head>
3     <script>
4       function draw() {
5         var canvas = document.getElementById("canvas");
6         var context = canvas.getContext('2d');
7         context.save(); // save the default (root) co-ord system
8         context.fillStyle="#CC00FF"; // purple
9         context.fillRect(0,0,100,100); // positioned with TL corner at 0,0
10        // translate then rotate
11        context.translate(100,0);
12        context.rotate(Math.PI/3);
13        context.fillStyle="#FF0000"; // red
14        context.fillRect(0,0,100,100); // positioned with TL corner at 0,0
15        // recover the root co-ord system
16        context.restore();
17        // rotate then translate
18        context.rotate(Math.PI/3);
19        context.translate(100,0);
20        context.fillStyle="#FFFF00"; // yellow
21        context.fillRect(0,0,100,100); // positioned with TL corner at 0,0
22      }
23    </script>
24  </head>
25  <body onload="draw();">
26    <canvas id="canvas" width="600" height="600"></canvas>
27  </body>
28 </html>

```



Figure 12: Rendering of the Above JavaScript Code

#### 4.1.7 Scaling

```

1 <html>
2   <head>
3     <script>
4       function draw() {
5         var canvas = document.getElementById("canvas");
6         var context = canvas.getContext('2d');
7         context.fillStyle="#CC00FF"; // purple
8         context.fillRect(0,0,100,100); // positioned with TL corner at 0,0
9         context.translate(150,0);
10        context.scale(2,1.5);
11        context.fillStyle="#FF0000"; // red
12        context.fillRect(0,0,100,100); // positioned with TL corner at 0,0
13      }
14    </script>
15  </head>
16  <body onload="draw();" >
17    <canvas id="canvas" width="600" height="600"></canvas>
18  </body>
19 </html>

```



Figure 13: Rendering of the Above JavaScript Code

#### 4.1.8 Canvas2D: Programmatic Graphics

```

1 <html>
2   <head>
3     <script>
4       function draw() {
5         var canvas = document.getElementById("canvas");
6         var context = canvas.getContext('2d');
7         context.translate(150,150);
8         for (i=0;i<15;i++) {
9           context.fillStyle = "rgb("+(i*255/15)+",0,0)";

```

```

10         context.fillRect(0,0,100,100);
11         context.rotate(2*Math.PI/15);
12     }
13 }
14 </script>
15 </head>
16 <body onload="draw();" >
17     <canvas id="canvas" width="600" height="600"></canvas>
18 </body>
19 </html>

```

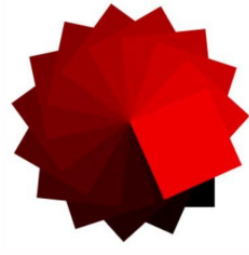

Figure 14: Rendering of the Above JavaScript Code

## 5 3D Co-Ordinate Systems

In a 3D co-ordinate system, a point  $P$  is referred to by three real numbers (co-ordinates):  $(x, y, z)$ . The directions of  $x$ ,  $y$ , &  $z$  are not universally defined but normally follow the **right-hand rule** for axes systems. In this case,  $z$  defined the co-ordinate's distance "out of" the monitor and negative  $z$  values go "into" the monitor.

### 5.1 Nested Co-Ordinate Systems

A **nested co-ordinate system** is defined as a translation relative to the world co-ordinate system. For example,  $-3.0$  units along the  $x$  axis,  $2.0$  units along the  $y$  axis, and  $2.0$  units along the  $z$  axis.

### 5.2 3D Transformations

#### 5.2.1 Translation

To translate a 3D point, modify each dimension separately:

$$x' = x + a_1$$

$$y' = y + a_2$$

$$z' = z + a_3$$

$$[x' \quad y' \quad z' \quad 1] = [x \quad y \quad z \quad 1] \begin{bmatrix} 1 & 0 & 0 & 0 \\ 0 & 1 & 0 & 0 \\ 0 & 0 & 1 & 0 \\ a_1 & a_2 & a_3 & 1 \end{bmatrix}$$

#### 5.2.2 Rotation About Principal Axes

A **principal axis** is an imaginary line through the "center of mass" of a body around which the body rotates.

- Rotation around the  $x$ -axis is referred to as **pitch**.

- Rotation around the  $y$ -axis is referred to as **yaw**.
- Rotation around the  $z$ -axis is referred to as **roll**.

**Rotation matrices** define rotations by angle  $\alpha$  about the principal axes.

$$R_x = \begin{bmatrix} 1 & 0 & 0 \\ 0 & \cos \alpha & \sin \alpha \\ 0 & -\sin \alpha & \cos \alpha \end{bmatrix}$$

To get new co-ordinates after rotation, multiply the point  $[x \ y \ z]$  by the rotation matrix:

$$[x' \ y' \ z'] = [x \ y \ z] R_x$$

For example, as a point rotates about the  $x$ -axis, its  $x$  component remains unchanged.

### 5.2.3 Rotation About Arbitrary Axes

You can rotate about any axis, not just the principal axes. You specify a 3D point, and the axis of rotation is defined as the line that joins the origin to this point (e.g., a toy spinning top will rotate about the  $y$ -axis, defined as  $(0, 1, 0)$ ). You must also specify the amount to rotate by, this is measured in radians (e.g.,  $2\pi$  radians is  $360^\circ$ ).

## 6 Graphics APIs

**Low-level** graphics APIs are libraries of graphics functions that can be accessed from a standard programming language. They are typically procedural rather than descriptive, i.e. the programmer calls the graphics functions which carry out operations immediately. The programmer also has to write all other application code: interface, etc. Procedural programming languages are typically faster than descriptive programming languages. Examples include OpenGL, DirectX, Vulkan, Java Media APIs. Examples that run in the browser include Canvas2D, WebGL, SVG.

**High-level** graphics APIs are ones in which the programmer describes the required graphics, animations, interactivity, etc. and doesn't need to deal with how this will be displayed & updated. They are typically descriptive rather than procedural and so are generally slower & less flexible because it is generally interpreted and rather general-purpose rather than task-specific. Examples include VRML/X3D.

### 6.1 Three.js

**WebGL (Web Graphics Library)** is a JavaScript API for rendering interactive 2D & 3D graphics within any compatible web browser without the use of plug-ins. WebGL is fully integrated with other web standards, allowing GPU-accelerated usage of physics & image processing and effects as part of the web page canvas.

**Three.js** is a cross-browser JavaScript library and API used to create & display animated 4D computer graphics in a web browser. Three.js uses WebGL.

```

1 <html>
2 <head>
3
4 <script src="three.js"></script>
5 <script>
6   'use strict'
7
8   function draw() {
9     // create renderer attached to HTML Canvas object
10    var c = document.getElementById("canvas");
11    var renderer = new THREE.WebGLRenderer({ canvas: c, antialias: true });
12

```

```

13 // create the scenegraph
14 var scene = new THREE.Scene();
15
16 // create a camera
17 var fov = 75;
18 var aspect = 600/600;
19 var near = 0.1;
20 var far = 1000;
21 var camera = new THREE.PerspectiveCamera( fov, aspect, near, far );
22 camera.position.z = 100;
23
24 // add a light to the scene
25 var light = new THREE.PointLight(0xFFFF00);
26 light.position.set(10, 30, 25);
27 scene.add(light);
28
29 // add a cube to the scene
30 var geometry = new THREE.BoxGeometry(20, 20, 20);
31 var material = new THREE.MeshLambertMaterial({color: 0xfd59d7});
32 var cube = new THREE.Mesh(geometry, material);
33 scene.add(cube);
34
35 // render the scene as seen by the camera
36 renderer.render(scene, camera);
37 }
38 </script>
39 </head>
40
41 <body onload="draw();">
42   <canvas id="canvas" width="600" height="600"></canvas>
43 </body>
44 </html>

```

Listing 1: “Hello World” in Three.js

In Three.js, a visible object is represented as a **mesh** and is constructed from a *geometry* & a *material*.

### 6.1.1 3D Primitives

Three.js provides a range of primitive geometry as well as the functionality to implement more complex geometry at a lower level. See <https://threejs.org/manual/?q=prim#en/primitives>.

```

1 <html>
2 <head>
3
4 <script src="three.js"></script>
5 <script>
6   'use strict'
7
8   var scene;
9
10  function addGeometryAtPosition(geometry, x, y, z) {
11    var material = new THREE.MeshLambertMaterial({color: 0xffffffff});
12    var mesh = new THREE.Mesh(geometry, material);

```



```

13     scene.add(mesh);
14     mesh.position.set(x,y,z);
15 }
16
17 function draw() {
18     // create renderer attached to HTML Canvas object
19     var c = document.getElementById("canvas");
20     var renderer = new THREE.WebGLRenderer({ canvas: c, antialias: true });
21
22     // create the scenegraph (global variable)
23     scene = new THREE.Scene();
24
25     // create a camera
26     var fov = 75;
27     var aspect = 400/600;
28     var near = 0.1;
29     var far = 1000;
30     var camera = new THREE.PerspectiveCamera( fov, aspect, near, far );
31     camera.position.z = 100;
32
33     // add a light to the scene
34     var light = new THREE.PointLight(0xFFFF00);
35     light.position.set(10, 0, 25);
36     scene.add(light);
37
38     // add a bunch of sample primitives to the scene
39     // see more here: https://threejsfundamentals.org/threejs/lessons/threejs-primitives.html
40
41     // args: width, height, depth
42     addGeometryAtPosition(new THREE.BoxGeometry(6,4,8), -50, 0, 0);
43
44     // args: radius, segments
45     addGeometryAtPosition(new THREE.CircleBufferGeometry(7, 24), -30, 0, 0);
46
47     // args: radius, height, segments
48     addGeometryAtPosition(new THREE.ConeBufferGeometry(6, 4, 24), -10, 0, 0);
49
50     // args: radiusTop, radiusBottom, height, radialSegments
51     addGeometryAtPosition(new THREE.CylinderBufferGeometry(4, 4, 8, 12), 20, 0, 0);
52
53     // arg: radius
54     // Polyhedrons
55     // (Dodecahedron is a 12-sided polyhedron, Icosahedron is 20-sided, Octahedron is 8-sided,
56     ↪ Tetrahedron is 4-sided)
57     addGeometryAtPosition(new THREE.DodecahedronBufferGeometry(7), 40, 0, 0);
58     addGeometryAtPosition(new THREE.IcosahedronBufferGeometry(7), -50, 20, 0);
59     addGeometryAtPosition(new THREE.OctahedronBufferGeometry(7), -30, 20, 0);
60     addGeometryAtPosition(new THREE.TetrahedronBufferGeometry(7), -10, 20, 0);
61
62     // args: radius, widthSegments, heightSegments
63     addGeometryAtPosition(new THREE.SphereBufferGeometry(7,12,8), 20, 20, 0);
64
65     // args: radius, tubeRadius, radialSegments, tubularSegments

```

```

65     addGeometryAtPosition(new THREE.TorusBufferGeometry(5,2,8,24), 40, 20, 0);
66
67     // render the scene as seen by the camera
68     renderer.render(scene, camera);
69 }
70 </script>
71 </head>
72
73 <body onload="draw();">
74   <canvas id="canvas" width="600" height="600"></canvas>
75 </body>
76 </html>

```

Listing 2: Code Illustrating Some Primitives Provided by Three.js

### 6.1.2 Cameras

3D graphics API cameras allow you to define:

- The camera location ( $x, y, z$ ).
- The camera orientation (straight,  $x$  rotation,  $y$  rotation,  $z$  rotation).
- The **viewing frustum** (the Field of View (FoV) & clipping planes).

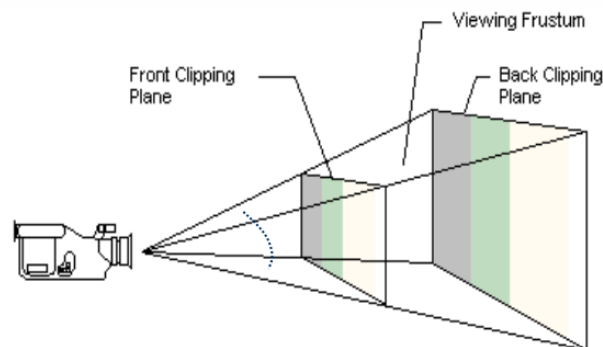

Figure 15: The Viewing Frustum

In Three.js, the FoV can be set differently in the vertical and horizontal directions via the first & second arguments to the constructor can be set differently in the vertical and horizontal directions via the first & second arguments to the constructor (`fov, aspect`). Generally speaking, the aspect ratio should match that of the canvas width & height to avoid the scene appearing to be stretched.

### 6.1.3 Lighting

Six different types of lights are available in both Three.js & WebGL:

- **Point lights:** rays emanate in all directions from a 3D point source (e.g., a lightbulb).
- **Directional lights:** rays emanate in one direction only from infinitely far away (similar effect rays from the Sun, i.e. very far away).
- **Spotlights:** project a cone of light from a 3D point source aimed at a specific target point.
- **Ambient lights:** simulate in a simplified way the lighting of an entire scene due to complex light/surface interactions – lights up everything in the scene regardless of position or occlusion.

- **Hemisphere lights:** ambient lights that affect the “ceiling” or “floor” hemisphere of objects rather than affecting them in their entirety.
- **RectAreaLights:** emit rectangular areas of light (e.g., fluorescent light strip).

```

1 <html>
2 <head>
3 <script src="three.js"></script>
4 <script>
5   'use strict'
6
7   function draw() {
8     // create renderer attached to HTML Canvas object
9     var c = document.getElementById("canvas");
10    var renderer = new THREE.WebGLRenderer({ canvas: c, antialias: true });
11
12    // create the scenegraph
13    var scene = new THREE.Scene();
14
15    // create a camera
16    var fov = 75;
17    var aspect = 600/600;
18    var near = 0.1;
19    var far = 1000;
20    var camera = new THREE.PerspectiveCamera( fov, aspect, near, far );
21    camera.position.set(0, 10, 30);
22
23    // add a light to the scene
24    var light = new THREE.PointLight(0xFFFFFF);
25    light.position.set(0, 10, 30);
26    scene.add(light);
27
28    // add a cylinder
29    // args: radiusTop, radiusBottom, height, radialSegments
30    var cyl = new THREE.Mesh(
31      new THREE.CylinderBufferGeometry(1, 1, 10, 12),
32      new THREE.MeshLambertMaterial({color: 0xAAAAAA} ) );
33    scene.add(cyl);
34
35    // clone the cylinder
36    var cyl2 = cyl.clone();
37
38    // modify its rotation by 60 degrees around its z axis
39    cyl2.rotateOnAxis(new THREE.Vector3(0,0,1), Math.PI/3);
40    scene.add(cyl2);
41    // clone the cylinder again
42    var cyl3 = cyl.clone();
43    scene.add(cyl3);
44    // set its rotation directly using "Euler angles", to 120 degrees on z axis
45    cyl3.rotation.set(0,0,2*Math.PI/3);
46
47    // render the scene as seen by the camera
48    renderer.render(scene, camera);

```

```

49     }
50   </script>
51 </head>
52
53 <body onload="draw();" >
54   <canvas id="canvas" width="600" height="600"></canvas>
55 </body>
56 </html>

```

Listing 3: Rotation Around a Local Origin in Three.js

#### 6.1.4 Nested Co-Ordinates

**Nested co-ordinates** help manage complexity as well as promote reusability & simplify the transformations of objects composed of multiple primitive shapes. In Three.js, 3D objects have a `children` array; a child can be added to an object using the method `.add(childObject)`, i.e. nesting the child object's transform within the parent object. Objects have a parent in the scene graph so when you set their transforms (translation, rotation) it's relative to that parent's local co-ordinate system.

```

1 <html>
2 <head>
3
4 <script src="three.js"></script>
5 <script>
6   'use strict'
7
8   function draw() {
9     // create renderer attached to HTML Canvas object
10    var c = document.getElementById("canvas");
11    var renderer = new THREE.WebGLRenderer({ canvas: c, antialias: true });
12
13    // create the scenegraph
14    var scene = new THREE.Scene();
15
16    // create a camera
17    var fov = 75;
18    var aspect = 600/600;
19    var near = 0.1;
20    var far = 1000;
21    var camera = new THREE.PerspectiveCamera( fov, aspect, near, far );
22    camera.position.set(0, 1.5, 6);
23
24    // add a light to the scene
25    var light = new THREE.PointLight(0xFFFFFF);
26    light.position.set(0, 10, 30);
27    scene.add(light);
28
29    // desk lamp base
30    // args: radiusTop, radiusBottom, height, radialSegments
31    var base = new THREE.Mesh(
32      new THREE.CylinderBufferGeometry(1, 1, 0.1, 12),
33      new THREE.MeshLambertMaterial({color: 0xAAAAAA} ) );
34    scene.add(base);

```

```

35
36 // desk lamp first arm piece
37 var arm = new THREE.Mesh(
38     new THREE.CylinderBufferGeometry(0.1, 0.1, 3, 12),
39     new THREE.MeshLambertMaterial({color: 0xAAAAAA} ) );
40
41 // since we want to rotate around a point other than the arm's centre,
42 // we can create a pivot point as the parent of the arm, position the
43 // arm relative to that pivot point, and apply rotation on the pivot point
44 var pivot = new THREE.Object3D();
45 // centre of rotation we want
46 // (in world coordinates, since pivot is not yet a child of the base)
47 pivot.position.set(0, 0, 0);
48 pivot.add(arm); // pivot is parent of arm
49 base.add(pivot); // base is parent of pivot
50
51 // translate arm relative to its parent, i.e. 'pivot'
52 arm.position.set(0, 1.5, 0);
53 // rotate pivot point relative to its parent, i.e. 'base'
54 pivot.rotateOnAxis(new THREE.Vector3(0,0,1), -Math.PI/6);
55
56 // clone a second arm piece (consisting of a pivot with a cylinder as its child)
57 var pivot2 = pivot.clone();
58 // add as a child of the 1st pivot
59 pivot.add(pivot2);
60 // rotate the 2nd pivot relative to the 1st pivot (since it's nested)
61 pivot2.rotation.z = Math.PI/3;
62 // translate the 2nd pivot relative to the 1st pivot
63 pivot2.position.set(0,3,0);
64
65 // TEST: we can rotate the 1st arm piece and the 2nd arm piece should stay correct
66 pivot.rotateOnAxis(new THREE.Vector3(0,0,1), Math.PI/12);
67
68 // TEST: we can also move the base, and everything stays correct
69 base.position.x -= 3;
70
71 // render the scene as seen by the camera
72 renderer.render(scene, camera);
73 }
74 </script>
75 </head>
76
77 <body onload="draw();">
78     <canvas id="canvas" width="600" height="600"></canvas>
79 </body>
80 </html>

```

Listing 4: Partial Desk Lamp with Nested Objects

The above code creates a correctly set-up hierarchy of nested objects, allowing us to:

- Translate the base while the two arms remain in the correct relative position.
- Rotate the first arm while keeping the second arm in the correct position.

### 6.1.5 Geometry Beyond Primitives

In Three.js, the term “low-level geometry” is used to refer to geometry objects consisting of vertices, faces, & normal.

## 7 Animation & Interactivity

### 7.1 Handling the Keyboard

Handling the keyboard involves recognising keypresses and updating the graphics in response.

Listing 5: Keyboard Handling (Canvas/JavaScript)

### 7.2 Mouse Handling

Listing 6: Mouse Handling (Canvas/JavaScript)

### 7.3 Time-Based Animation

Time-based animation can be achieved using `window.setTimeout()` which repaints the canvas at pre-defined intervals.

Listing 7: Time-Based Animation with `window.setTimeout()`

However, improved smoothness can be achieved using `window.requestAnimationFrame()` which is called at every window repaint/refresh.

Listing 8: Smoother Time-Based Animation with `window.requestAnimationFrame()`

### 7.4 Raycasting

**Raycasting** is a feature offered by 3D graphics APIs which computes a ray from a start position in a specified direction and identifies the geometry that the ray hits.

```
1 renderer = new THREE.WebGLRenderer({ canvas: c, antialias: true });
```

The following example illustrates the use of raycasting/picking and rotation/translation based on mouse selection and mouse movement. It also illustrates how nested co-ordinate systems have been used to make the lamp parts behave correctly.

Listing 9: Controllable Desk Lamp

### 7.5 Shading Algorithms

The colour at any pixel on a polygon is determined by:

- The characteristics (including colour) of the surface itself.
- Information about light sources (ambient, directional, parallel, point, or spot) and their positions relative to the surface.
- *Diffuse & specular* reflections.

Classic shading algorithms include:

- Flat shading.
- Smooth shading (Gourard).
- Normal Interpolating Shading (Phong).



Figure 16: Different Shading Algorithms

### 7.5.1 Flat Shading

**Flat shading** calculates and applies directly the shade of each surface, which is calculated via the cosine of the angle of incidence ray to the *surface normal* (a **surface normal** is a vector perpendicular to the surface).

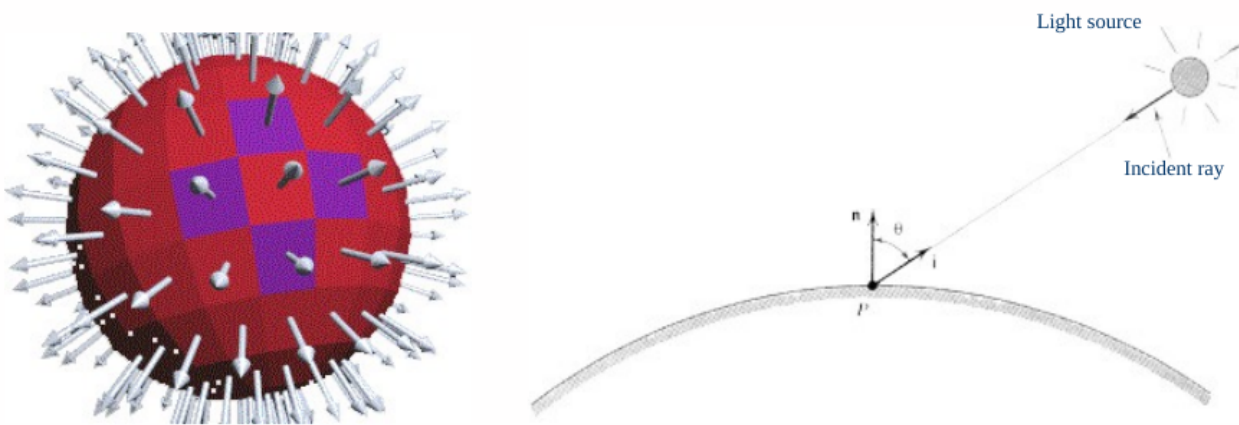

Figure 17: Flat Shading

### 7.5.2 Smooth (Gourard) Shading

**Smooth (Gourard) shading** calculates the shade at each vertex, and interpolates (smooths) these shades across the surfaces. Vertex normals are calculated by averaging the normals of the connected faces. Interpolation is often carried out in graphics hardware, making it generally very fast.

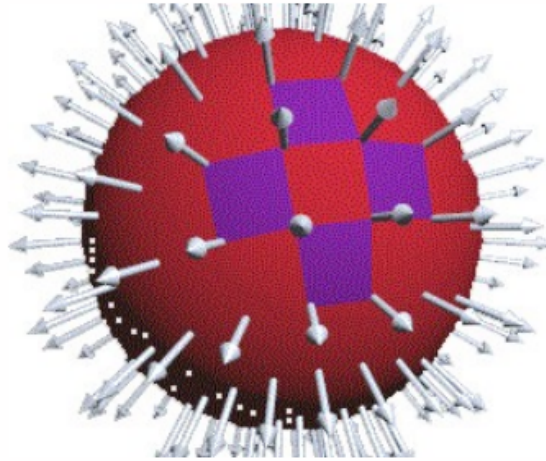

Figure 18: Smooth Shading

### 7.5.3 Normal Interpolating (Phong) Shading

**Normal interpolating (Phong) shading** calculates the normal at each vertex and interpolates these normals across the surfaces. The light, and therefore the shade at each pixel is individually calculated from its unique surface normal.

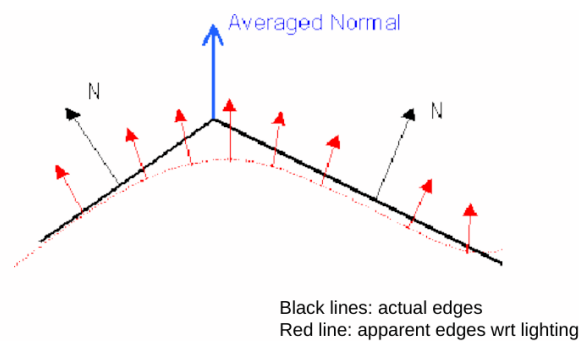

Figure 19: Normal Interpolating (Phong) Shading

## 7.6 Shading in Three.js

In Three.js, **materials** define how objects will be shaded in the scene. There are three different shading models to choose from:

- `MeshBasicMaterial`: none.
- `MeshPhongMaterial` (with `flatShading = true`): flat shading.
- `MeshLambertMaterial`: Gourard shading.

## 7.7 Shadows in Three.js

Three.js supports the use of shadows although they are expensive to use. The scene is redrawn for each shadow-casting light, and finally composed from all the results. Games sometimes use fake “blob shadows” instead of proper shadows or else only let one light cast shadows to save computation.

## 7.8 Reflectivity of Materials in Three.js

There are a variety of colour settings in Three.js



- **Diffuse colour** is defined by the colour of the material.
- **Specular colour** is the colour of specular highlights (in Phong shading only).
- **Shininess** is the strength of specular highlights (in Phong only).
- **Emissive colour** is not affected by lighting.

## 8 Image Processing

The difference between Graphics, Image Processing, & Computer Vision is as follows:

- **Graphics** is the processing & display of images of objects that exist conceptually rather than physically, with emphasis on the generation of an image from a model of the objects, illumination, etc. and an emphasis on the rendering efficiency for real-time display and/or realism.
- **Image Processing** is the processing & analysis of images of the real world, with an emphasis on the modification of the image.
- **Computer Vision** uses image processing, techniques from AI, & pattern recognition to recognise & categorise image data and extract domain-specific information from these images.

Image processing techniques include:

- **Image Enhancement:** provide a more effective display of data for visual interpretation or increase the visual distinction between features in the image.
- **Image Restoration:** correction of geometric distortions, de-noising, de-blurring, etc.
- **Feature Extraction:** the extraction of useful features, e.g. corners, blobs, edges, & lines, the extraction of image segments & regions of interest, and the subtraction of background to extract foreground objects.

Image processing applications include industrial inspection, document image analysis, traffic monitoring, security and surveillance, remote sensing, scientific imaging, medical imaging, robotics and autonomous systems, face analysis and biometric, & entertainment

### 8.1 Introduction to OpenCV

**Open Source Computer Vision Library (OpenCV)** is an open source computer vision & machine learning software library which is available for Python, C++, JavaScript, & Java. It is a good choice for high-performance image processing and for making use of pre-built library functions.

You can also write image processing code directly using Canvas & JavaScript or Matlab Image Processing & Computer Vision toolboxes.

### 8.2 Point Transformations

**Point transformations** modify the value of each pixel.

#### 8.2.1 Histogram Manipulation

A **histogram** is a graphical representation of the distribution of pixel intensity values in an image. It displays the number of pixels for each intensity level, allowing us to understand the image's overall brightness & contrast. Histogram manipulation utilises the following processes:

- **Contrast Stretching:** enhancing the contrast of an image by spreading out the intensity values across the available range, with the goal of making the distinction between different pixel values more apparent. **Uniform expansion / linear stretch** is a method of contrast stretching that assigns a proportional number of grey levels to both frequently & rarely occurring pixel values. It aims to ensure that every pixel intensity has a chance to

occupy the full range of values, and can be applied either globally (to the entire image) or locally (to smaller regions).

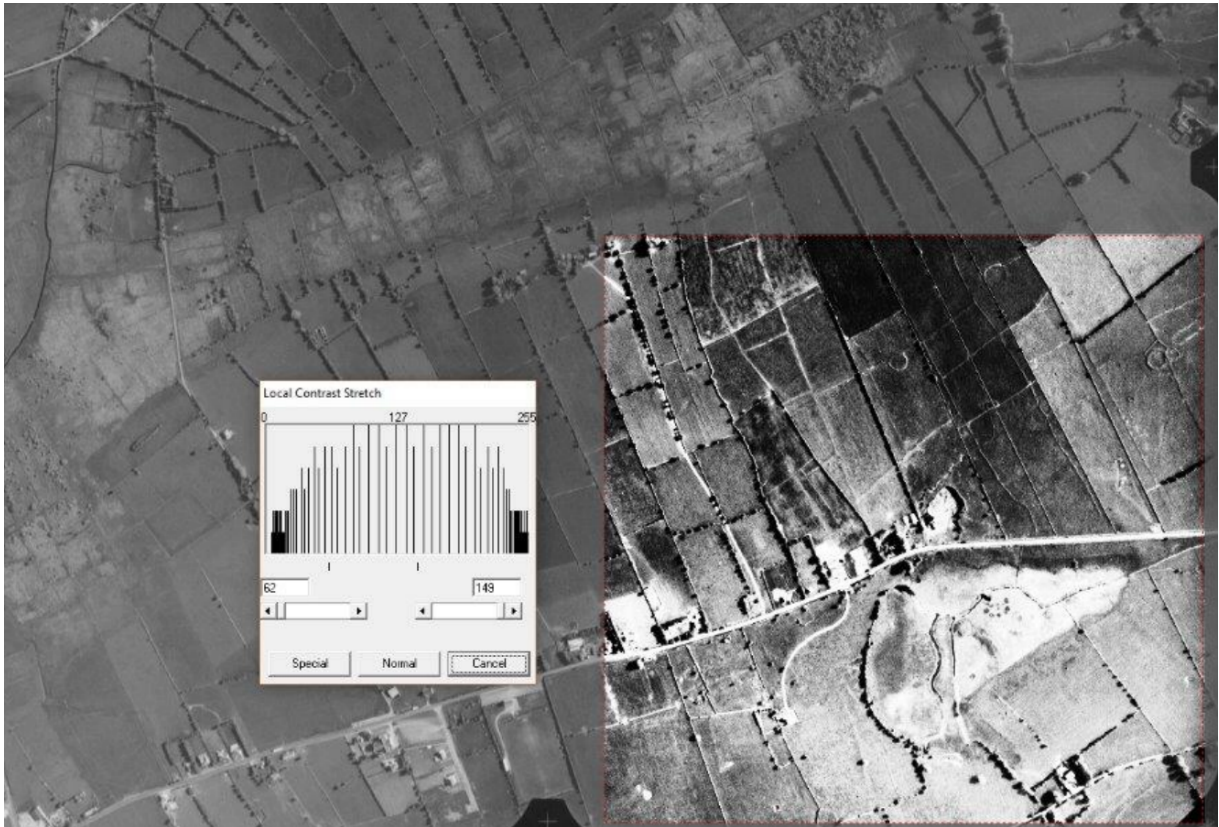

Figure 20: Aerial Photograph with a Local Histogram Stretch Applied

- **Histogram Equalisation** is a process that adjusts the intensity distribution of an image to achieve a uniform histogram. It enhances contrast by redistributing pixel values, which helps in revealing more details, particularly in images where some pixel values are too dominant or too rare.

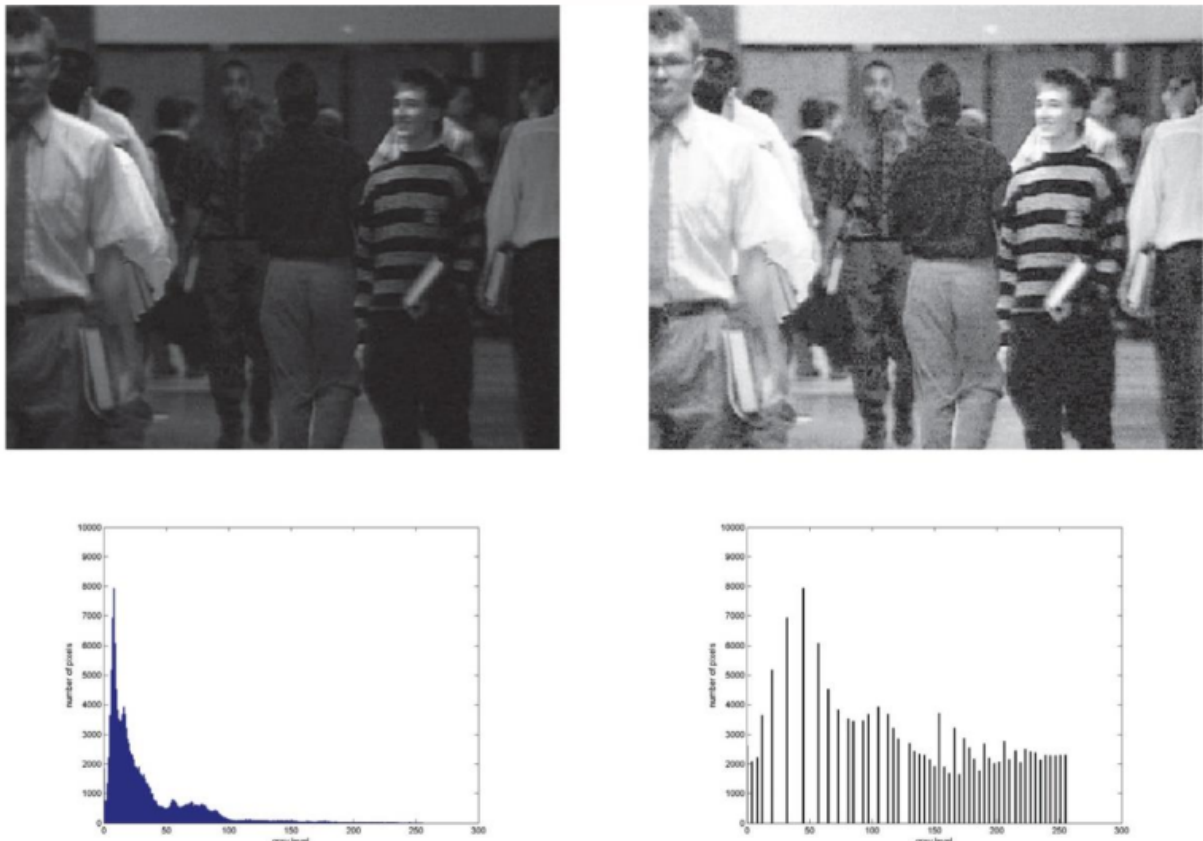

Figure 21: Histogram Equalisation Applied with Discretisation Effects

### 8.2.2 Thresholding

**Thresholding** is a simple segmentation technique that is very useful for separating solid objects from a contrasting background. All pixels above a determined threshold grey level are assumed to belong to the object, and all pixels below that level are assumed to be outside that object (or vice-versa). The selection of the threshold level is very important: problems of over-segmentation exist (false negatives) and under-segmentation (false positives).

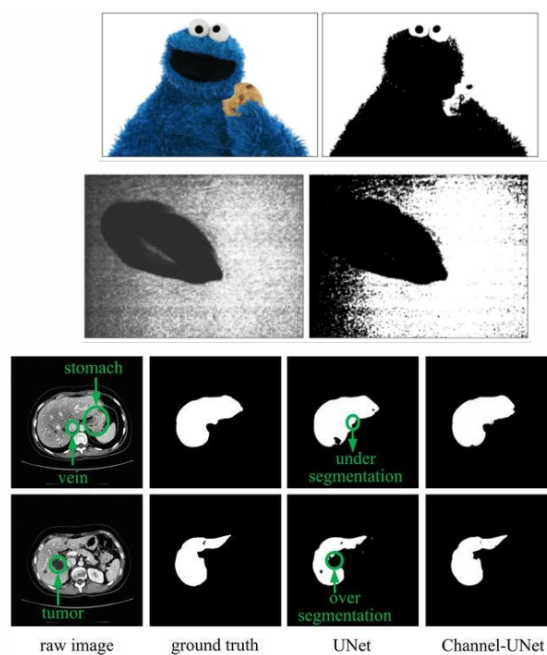

Figure 22: Thresholding Examples

## 8.3 Geometric Transformations

### 8.3.1 Interpolation

As a 2D array of values, a digital image can be thought of as a sampling of an underlying continuous function. Interpolation estimates this underlying continuous function by computing pixel values at real-valued co-ordinates where the estimated continuous function must coincide with the sampled data at the sample points. Types of interpolation include:

- Nearest-neighbour interpolation.
- Bilinear interpolation which calculates a distance-weighted average of the four pixels closest to the target sub-pixel position  $(v, w)$ .
- Bicubic interpolation which is more accurate but costly, where derivatives of the underlying function are also estimated.

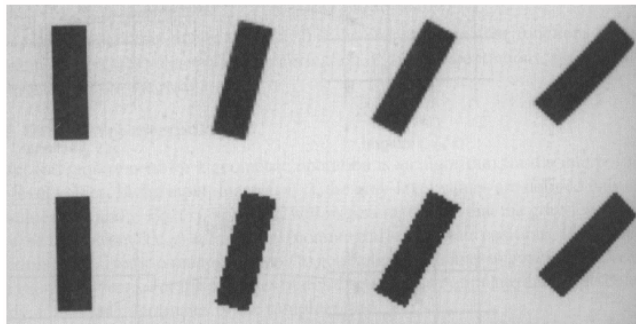

Using a rotation operation as an example, we can see how bilinear interpolation is superior to nearest neighbour interpolation

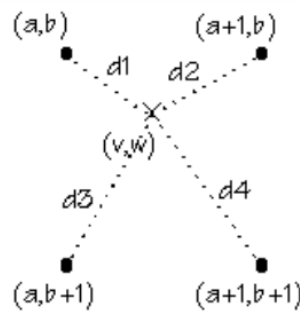

Figure 23: Interpolation Examples

### 8.3.2 Warping

**Warping** consists of arbitrary geometric transformations from real-valued co-ordinates  $(x, y)$  to real-valued co-ordinates  $(x', y')$  where the mapping function  $f(x, y)$  specifies the transformation, or *warping*. Applications include image rectification, image registration, map projection, & image morphing.

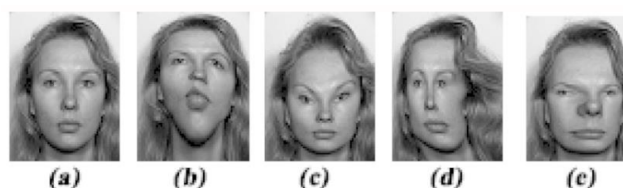

Figure 24: Warping Examples

### 8.3.3 Image Rectification

**Image rectification** (part of camera calibration) is a standard approach to geometric correction consisting of displacement values for specified control points in the image. Displacement of non-control points is determined through *interpolation*. For example, take a photograph of a rectangular grid and then determine the mapping required to move output control points back to known undistorted positions.

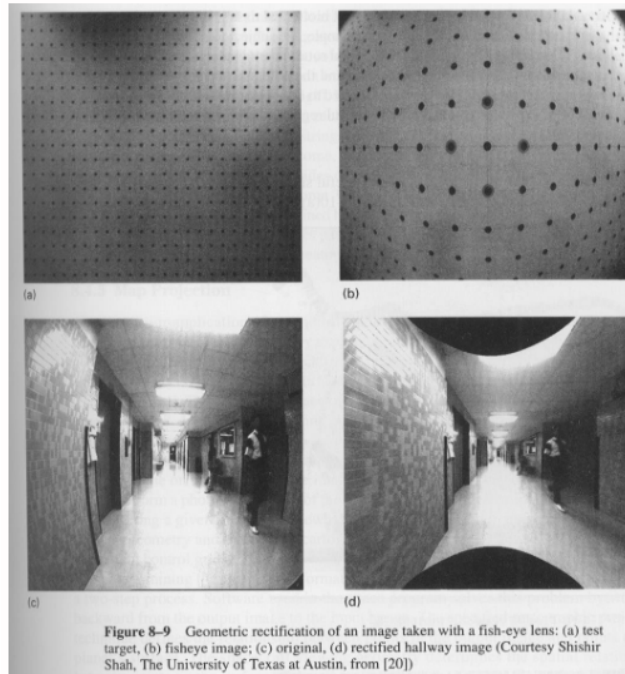

Figure 25: Image Rectification Examples

### 8.3.4 Image Registration

**Image registration** is the process of transforming different sets of data into one co-ordinate system. Geometric operations are applied to images for the purposes of comparison, monitoring, measurement, etc. and have many applications in medical imaging.

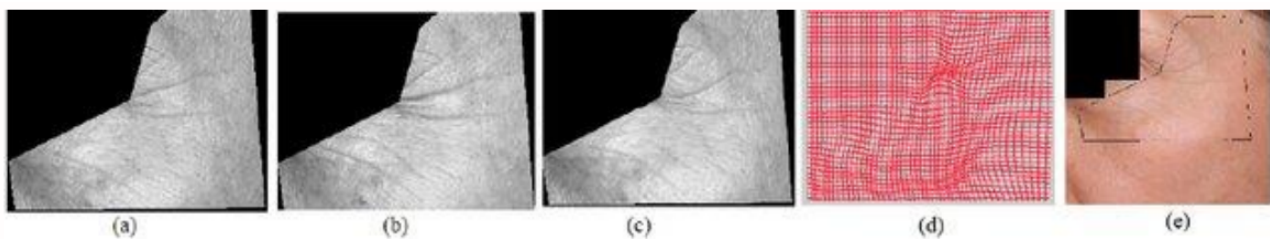

Figure 26: Image Registration Examples

### 8.3.5 Map Projection

Aerial or spaceborne images of the surface of a planet may be rectified into photomaps. Both oblique and orthogonol photographs require correction for this application due to the shape of the surface being imaged.

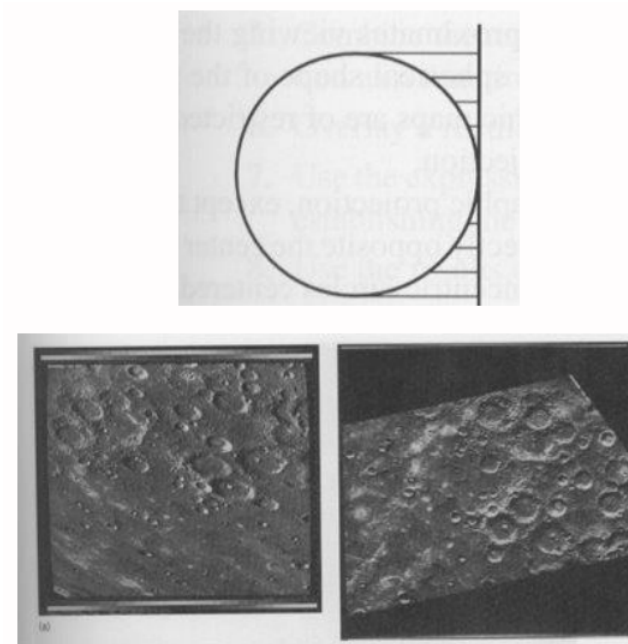

Figure 27: Map Projection Examples

### 8.3.6 Image Morphing

**Image morphing** gradually transforms one image into another over a number of animation frames. It involves a dissolve from one image to the other (i.e., gradual change of pixel values) as well as an incremental geometric operation using control points (e.g., nostrils, eyes, chin, etc.).

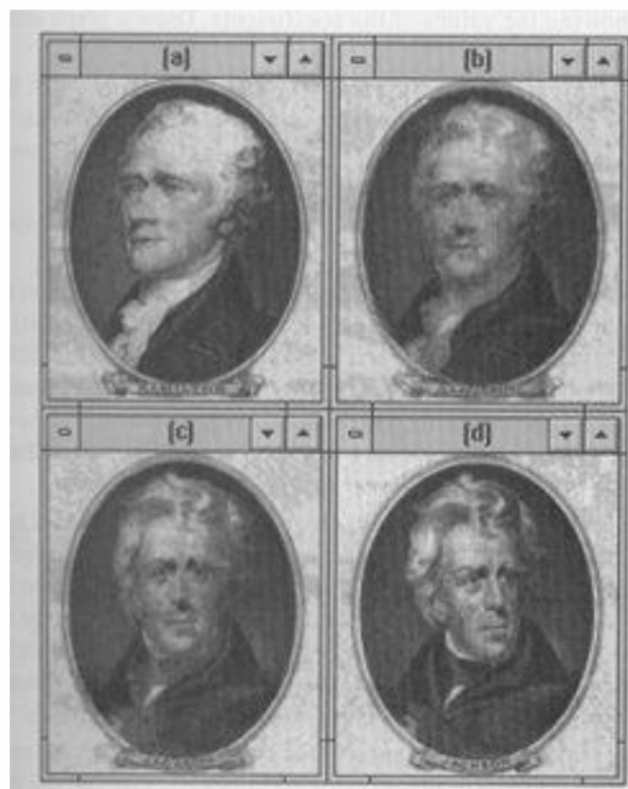

Figure 28: Image Morphing Examples

## 9 Spatial Filtering

Spatial filtering is a fundamental local operation in image processing that is used for a variety of tasks, including noise removal, blurring, sharpening, & edge detection. It establishes a moving window called a **kernel** which contains an array of coefficients or weighting factors. The kernel is then moved across the original image so that it centres on each pixel in turn. Each coefficient in the kernel is multiplied by the value of the pixel below it, and the addition of each of these values determines the value of the pixel in the output image corresponding to the pixel in the centre of the kernel.

- **Smoothing kernels** perform an averaging of the values in a local neighbourhood and therefore reduce the effects of noise. Such kernels are often used as the first stage of pre-processing an image that has been corrupted by noise in order to restore the original image.
- **Differentiating kernels** accentuate the places where the signal is changing in value rapidly. They are used to extract useful information from images, such as the boundaries of objects, for purposes such as object detection.



Figure 29: Spatial Filtering: Smoothing Filters

For symmetric kernels with real numbers and signals with real values (as is the case with images), convolution is the same as cross-correlation.

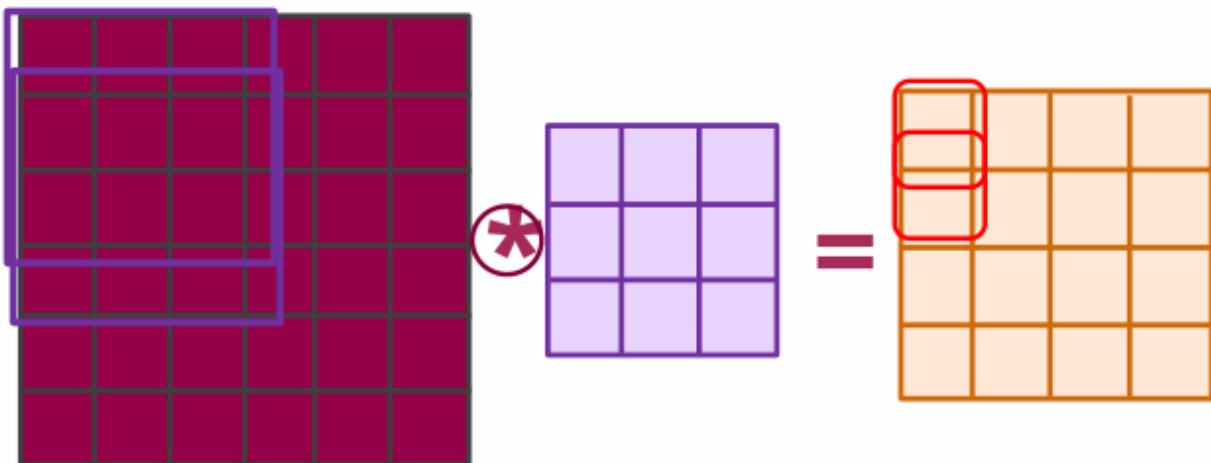

Figure 30: Convolution Operation Denoted by  $*$

### 9.1 Image Filtering for Noise Reduction

We typically use **smoothing** to remove *high-frequency noise* without unduly damaging the larger *low-frequency* objects of interest. Commonly used smoothing filters include:

- **Blur:** averages a pixel and its neighbours.
- **Median:** replaces a pixel with the median (rather than the mean) of the pixel and its neighbours.

- **Gaussian:** a filter that produces a smooth response (unlike blur/“box” & median filtering) by weighting more towards the centre.

A typical “classical” (pre-deep learning) computer vision pipeline consists of the following steps:

1. Clean-up / Pre-processing:

- Reduce noise (smoothing kernels).
- Remove geometric/radiometric distortion.
- Emphasise desired aspects of the image, e.g., edges, corners, blobs, etc. (differentiating kernels, feature detectors).

2. Segmentation:

- Identify / extract objects of interest.
- Sometimes the entire image is of interest, so the task is to separate it into non-overlapping regions.
- Most likely leverages domain-specific knowledge.
- Not always needed in deep learning based approaches.

3. Measurement:

- Quantify appropriate measurements on segmented objects.
- Might not be needed in deep learning based approaches.

4. Classification:

- Assign segmented objects to classes.
- Make decision etc.

## 9.2 Image Filtering for Edge Detection

Consider a horizontal slice across the image: **edge detection** filters are essentially performing a differentiation of the grey level with respect to distance, i.e., “how different is a pixel to its neighbours?”. Some filters are akin to *first derivatives* while others are more akin to *second derivatives*.

**Edge detection** is a common early step in image segmentation (often preceded by noise reduction). Edge detection determines how different pixels are from their neighbours: abrupt changes in brightness are interpreted as the edges of objects. Differentiating kernels can represent **first order** or **second order** derivatives. Differentiating kernels for edge detection can also be classified as **gradient magnitude** or **gradient direction**.

### 9.2.1 First Order Derivatives

The general image processing pipeline is as follows:

Smoothing (to reduce noise) → Derivative (so that noise is not accentuated)

Most differentiating kernels are built by combining these two operations. First order derivatives include:

- 1D Gaussian derivative kernels.
- 2D Gaussian derivative kernels: image gradients

$$\nabla f(x, y) = \left[ \frac{\partial f}{\partial x} \quad \frac{\partial f}{\partial y} \right]^T$$



In image processing, an image can be represented as a 2D function  $I(x, y)$  where  $x$  &  $y$  are spatial co-ordinates and  $I$  is the pixel intensity at those co-ordinates. The first-order derivatives in the  $x$ - &  $y$ -directions are defined as:

$$\frac{\partial I}{\partial x} \text{ and } \frac{\partial I}{\partial y}$$

These derivatives measure the rate of change of intensity in the horizontal & vertical directions respectively. The concept is the same as differentiating a function, but applied to discrete pixel values, usually using finite differences or convolution with derivative filters.

The **Prewitt operator** is the simplest 2D differentiating kernel. It is obtained by convolving a 1D Gaussian derivative kernel with a 1D box filter in the orthogonal direction. It is used to estimate the gradient of an image's intensity by highlighting regions with high spatial intensity variation, making it useful for detecting edges & boundaries. It uses two  $3 \times 3$  convolution kernels to approximate the first-order derivatives of the image in the horizontal & vertical directions.

$$\begin{aligned} \text{Prewitt}_x &= \frac{1}{3} \begin{bmatrix} 1 \\ 1 \\ 1 \end{bmatrix} \otimes \frac{1}{2} [1 \quad 0 \quad -1] = \frac{1}{6} \begin{bmatrix} 1 & 0 & -1 \\ 1 & 0 & -1 \\ 1 & 0 & -1 \end{bmatrix} \\ \text{Prewitt}_y &= \frac{1}{3} [1 \quad 1 \quad 1] \otimes \frac{1}{2} \begin{bmatrix} 1 \\ 0 \\ -1 \end{bmatrix} = \frac{1}{6} \begin{bmatrix} 1 & 0 & -1 \\ 1 & 0 & -1 \\ 1 & 0 & -1 \end{bmatrix} \end{aligned}$$

The **Sobel operator** is more robust than the Prewitt operator as it uses the Gaussian  $\sigma^2 = 0.5$  for the smoothing kernel:

$$\begin{aligned} \text{Sobel}_x &= \text{gauss}_{0.5}(y) \otimes \text{gauss}_{0.5}(x) = \frac{1}{4} \begin{bmatrix} 1 \\ 2 \\ 1 \end{bmatrix} \otimes \frac{1}{2} [1 \quad 0 \quad -1] = \frac{1}{8} \begin{bmatrix} 1 & 0 & -1 \\ 2 & 0 & -2 \\ 1 & 0 & 1 \end{bmatrix} \\ \text{Sobel}_y &= \text{gauss}_{0.5}(x) \otimes \text{gauss}_{0.5}(y) = \frac{1}{4} [1 \quad 2 \quad 1] \otimes \frac{1}{2} \begin{bmatrix} 1 \\ 0 \\ -1 \end{bmatrix} = \frac{1}{8} \begin{bmatrix} 1 & 2 & 1 \\ 0 & 0 & 0 \\ -1 & -2 & -1 \end{bmatrix} \end{aligned}$$

The **Scharr operator** is similar to the Sobel operator but with a smaller variance  $\sigma^2 = 0.375$  in the smoothing kernel.

### Magnitude Images using First Order Derivatives

Calculate “magnitude images” of the directional image gradients in the following image:



Figure 31: Example Image

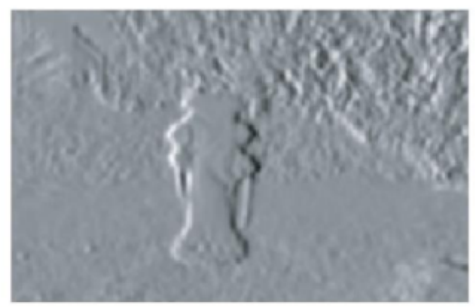

Figure 32: Partial Derivative in the  $x$  Direction



Figure 34: The Magnitude of the Gradient

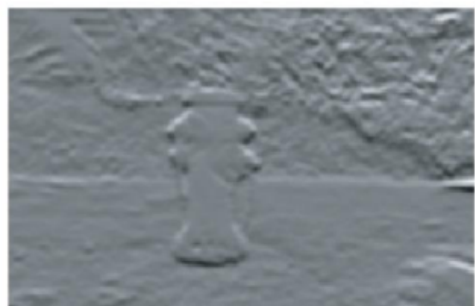

Figure 33: Partial Derivative in the  $y$  Direction



Figure 35: The Phase of the Gradient

The partial derivatives of the image in the  $x$  &  $y$  directions together form the two components of the gradient of the image.

### Edge Detection by Thresholding Magnitude Images

Calculate edges by thresholding “magnitude images” of the directional image gradients.

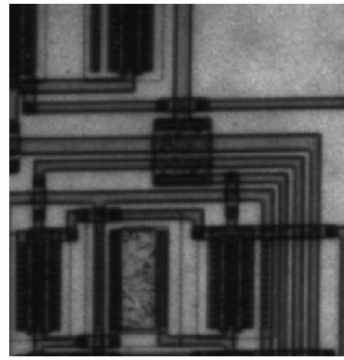

Figure 36: Input Greyscale Image

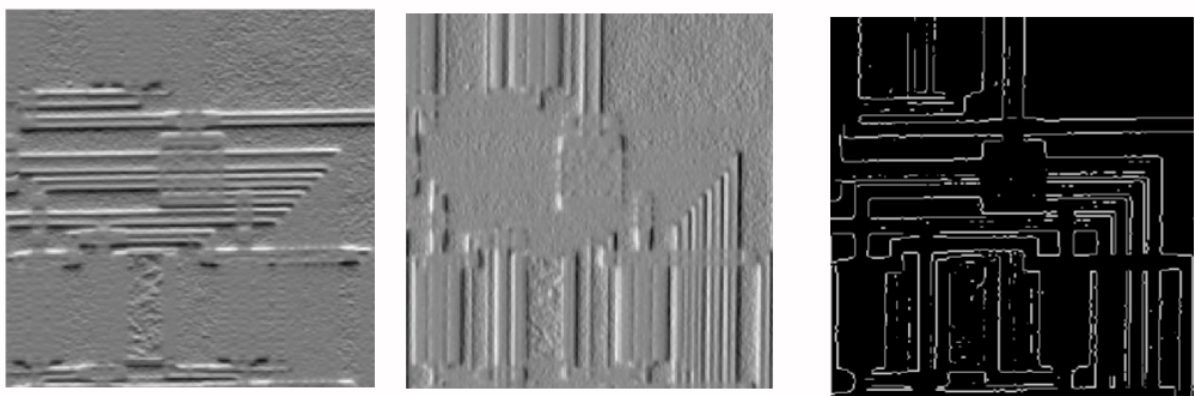

Figure 37: Prewitt Operator (Vertical Gradient, Horizontal Gradient, Thresholding Gradient Magnitude)

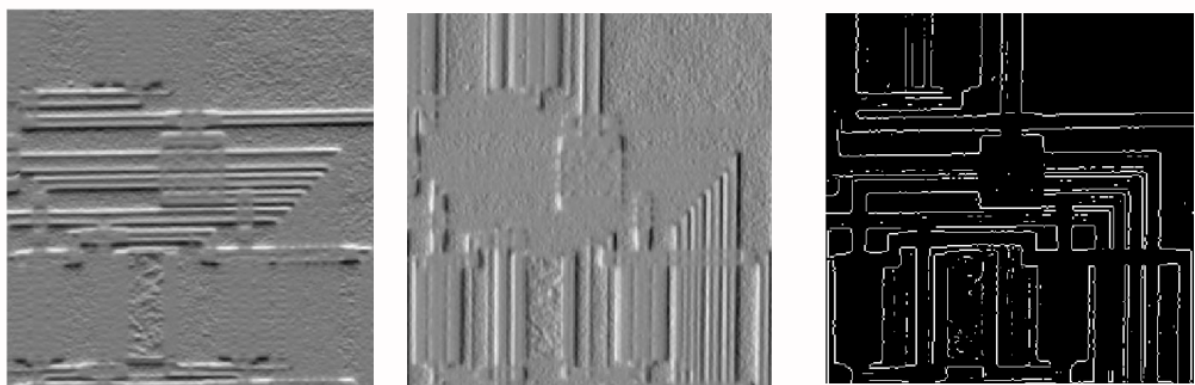

Figure 38: Sobel Operator (Vertical Gradient, Horizontal Gradient, Thresholding Gradient Magnitude)

#### 9.2.2 Second Order Derivatives

For a function (or image) of two variables, the **second order derivative** in the  $x$  &  $y$  directions can be obtained by convolving with the appropriately oriented **second-derivative kernel**. For a function or image  $I(x, y)$ , the second-order derivatives measure how the rate of change of the function changes, represented by  $\frac{\partial^2 I(x, y)}{\partial x^2}$  for the second derivative in the  $x$ -direction and  $\frac{\partial^2 I(x, y)}{\partial y^2}$  for the second derivative in the  $y$ -direction.

In image processing, second-order derivatives can be computed using specialised convolution kernels that act as second-derivative operators:

$$\frac{\partial^2 I(x, y)}{\partial x^2} = I(x, y) \otimes [1 \quad -2 \quad 1]$$

$$\frac{\partial^2 I(x, y)}{\partial y^2} = I(x, y) \otimes \begin{bmatrix} 1 \\ -2 \\ 1 \end{bmatrix}$$

These kernels detect changes in intensity by convolving with the image. When applied, they help identify where the intensity values change significantly, highlighting potential edges or other features.

These kernels are second-order derivatives because they involve convolving the function with a differentiating kernel twice. This can be seen in 1D by convolving the function with the non-centralised difference operator, then convolving the result again with the same operator:

$$(f(x) \otimes [1 \quad -1] \otimes [1 \quad -1]) = f(x) \otimes ([1 \quad -1] \otimes [1 \quad 01]) = f(x) \otimes [1 \quad -2 \quad 1]$$

Note that these 2D derivatives are not isotropic or symmetric.

COME BACK TO LAPLACIAN OPERATOR

### 9.3 Image Filtering in the Frequency Domain

Any signal, discrete or continuous, periodic or non-periodic, can be represented as a sum of sinusoidal waves of different frequencies and phases which constitute the frequency domain representation of that signal.

## 10 Morphological Image Processing

The term **morphology** refers to shape. Morphological image processing assumes that an image consists of structures that can be handled by mathematical set theory. It is normally applied to binary (black & white) images, e.g. after applying thresholding. A **set** is a group of pixels; different set operations can be performed on this set of pixels. Applications for morphological image analysis generally involve image analysis at a very small scale (i.e., small regions of pixels) e.g., medical image processing, scientific image processing, industrial inspection, etc.

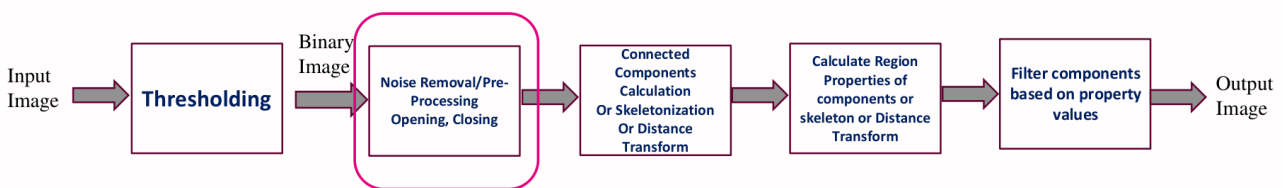

Figure 39: A General Morphological Image Processing Pipeline

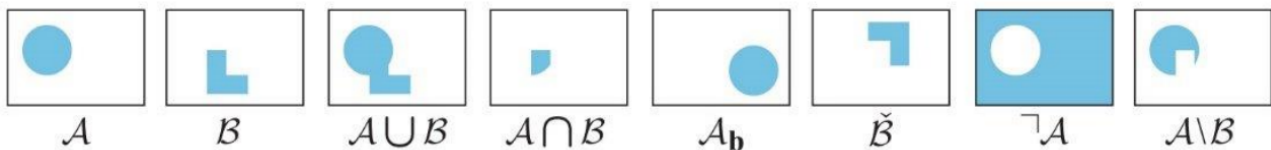

Figure 40: Basic Set Operators (From left to right: union, intersection, shift of  $A$  by some amount  $b$ , reflection about the origin (assumed to be at the center), complement, & set difference)

We can describe morphological differences in terms of intersections with test sets called **structuring elements (SEs)**. SEs are of a much smaller size than the original image. Morphological operations transform an image, i.e. changing a

pixel from black to white (or vice-versa) if a defined structuring element “fits” at that point. The shape + size of the structuring element directly affect the information about the image obtained by the operation.

### Structuring Elements Example

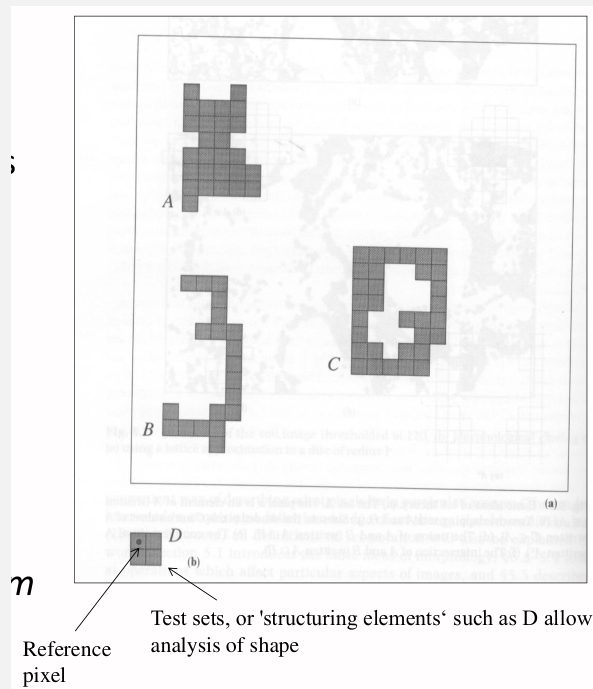

Figure 41: Structuring Elements Example

The three black objects  $A$ ,  $B$ , &  $C$  are very similar in size (i.e., number of pixels) but different in morphology/shape. E.g., several possible translations of  $D$  will fit into  $A$ , but none will fit into  $B$ .

## 10.1 Basic Morphological Operations

Basic morphological operations are performed by set operations between a given image and a structuring element, e.g., erosion, dilation, opening, closing.

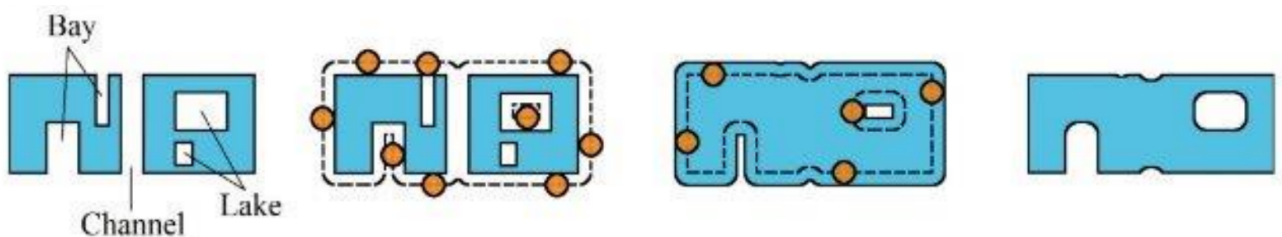

Figure 42: Dilation of a binary region by a circular structuring element can be visualised as rolling the disk along the outside of the region; the result is enclosed by the path of the centre of the disk. The right column shows the result of *closing* (dilation followed by erosion), which fills lakes, bays, & channels.

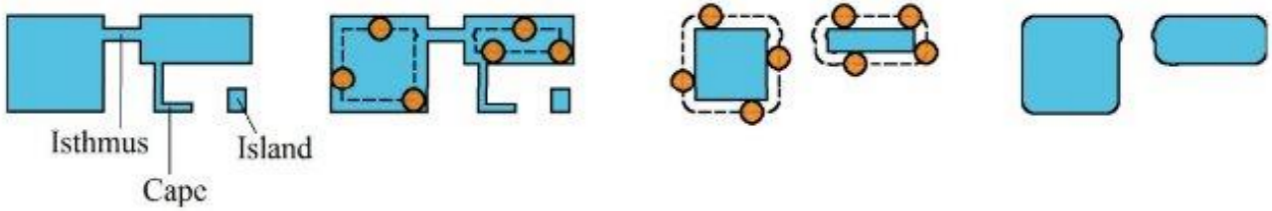

Figure 43: Erosion can be visualised as rolling the disk along the inside of the region; the result is again enclosed by the path of the centre of the disk. The right column shows the result of *opening* (erosion followed by dilation), which removes capes, isthmuses, & islands.

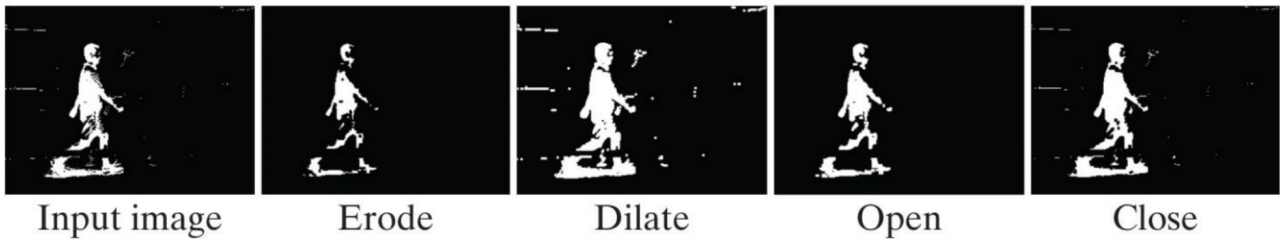

Figure 44: A binary image and the result of morphological operations: erode, dilate, open, & close. Erosion removes salt noise but shrinks the foreground. Dilate fills pepper noise but expands the foreground. Opening & closing removes the respective types of noise while retaining the overall size of the foreground.

**Thinning** is an operation used to reduce objects in a binary image to their skeletons without breaking their connectivity. It progressively removes pixels from the edges of objects while maintaining the general structure & topology. It can be thought of as “clever erosion” and is done by using crafter ternary structuring elements (on, off, don’t care).

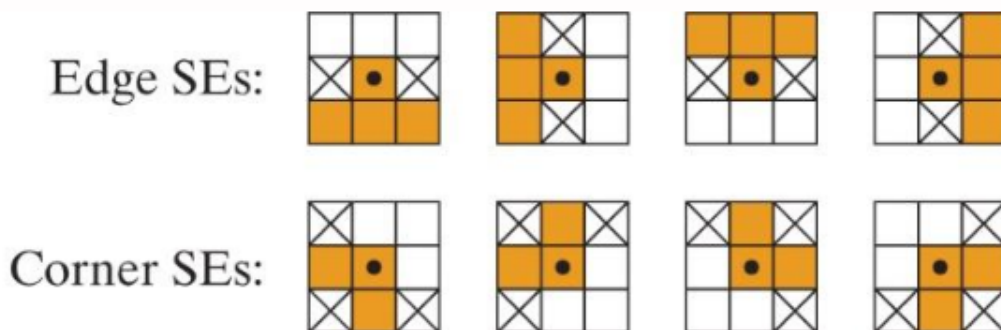

Figure 45: Structuring elements commonly used for morphological thinning. Coloured pixels are ON, white pixels are OFF, and X indicates DON’T-CARE. The top row shows the four edge SEs, while the bottom row shows the four corner SEs.

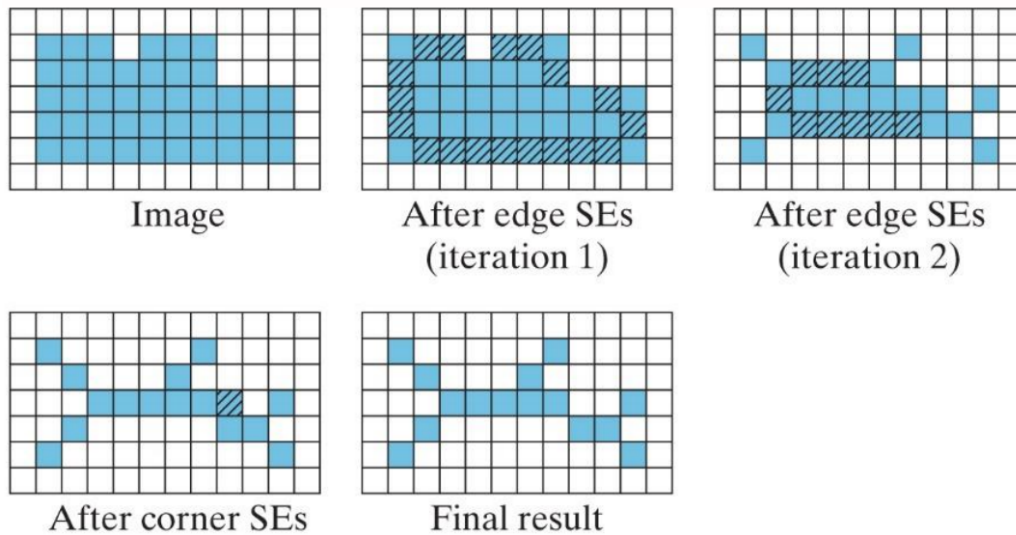

Figure 46: Morphological thinning of the same binary image using the same SEs as the previous example. In this case, however, the edge SEs are applied repeatedly as a set until convergence, before applying the corner SEs repeatedly as a sequence. In the first iteration, pixels along the top, right, bottom, & left of the region are removed by the edge SEs. In the second iteration, nine additional pixels are removed by the edge SEs. In the final iteration, a single pixel is removed by one of the corner SEs, thus producing a thinner skeleton than in the previous example.

**Thickening** is the opposite of thinning, i.e. adding pixels to the foreground.

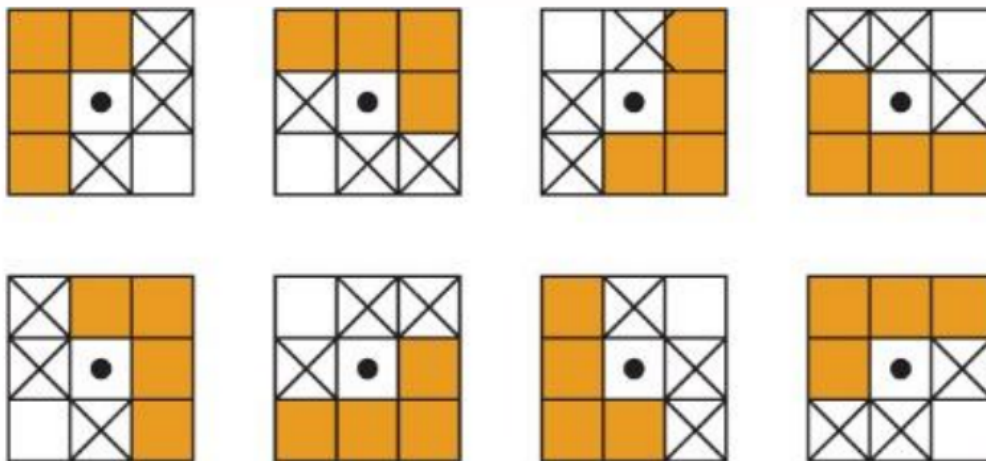

Figure 47: Structuring elements commonly used for morphological thickening.

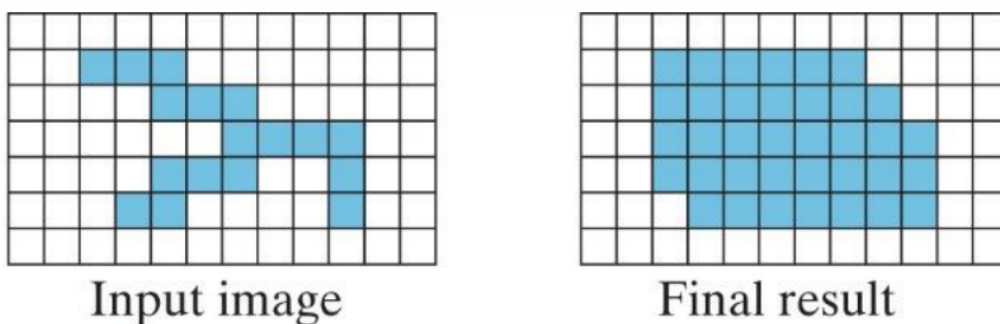

Figure 48: Morphological thickening of a binary image using the SEs above. Shown are the original image (left) and the final result after convergence (right). The thickened result is an approximation to the convex hull.

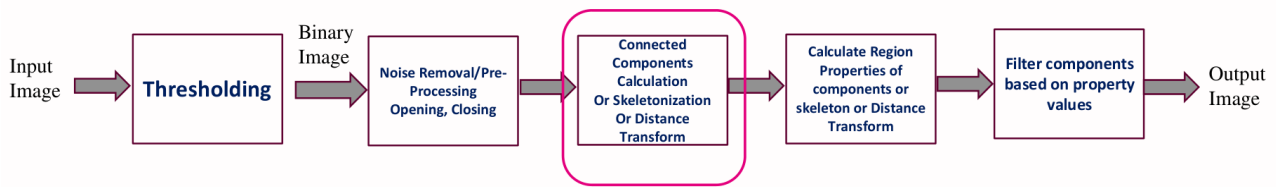
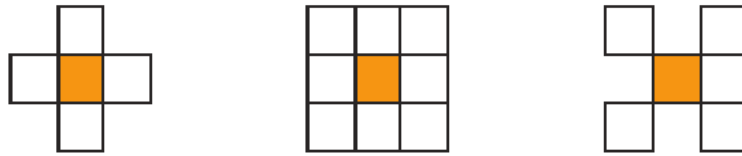
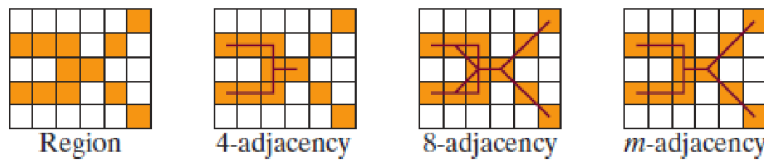

Figure 49: A general morphological image processing pipeline.

## 10.2 Connected Components

A pixel  $q = (q_x, q_y)$  is a neighbour of pixel  $p = (p_x, p_y)$  if  $q$  is in the **neighbourhood** of  $p$ , denoted  $q \in N(p)$  where  $N$  is the neighbourhood function. Two pixels are said to be **adjacent** if they have the same value and if they are neighbours of each other. Pixels are said to be **connected** or **contiguous** if there exists a path between them

Figure 50: Commonly used neighbourhoods. From left to right:  $N_4$ ,  $N_8$ , &  $N_D$ .Figure 51: A binary region and the 4-, 8-, &  $m$ -adjacency of its pixels. Note that  $m$ -adjacency removes the loops that sometimes occur with 8-adjacency.

A **connected component** is defined as a maximal set of pixels that are all connected with one another. **Connected component labelling** is the process of assigning a unique identifier to every pixel in the image indicating the connected component to which it belongs.

## 10.3 Distance Transform

A **distance transform** replaces pixels of one value (black or white) in a binary image with their distance to the nearest pixel of opposite value (white or black). This is useful for template matching & granulometry (studying the size distribution/properties of objects). The assumption is that a local maximum is the centre of a distinct object: use a “non-maximal suppressin” to remove all other pixels.



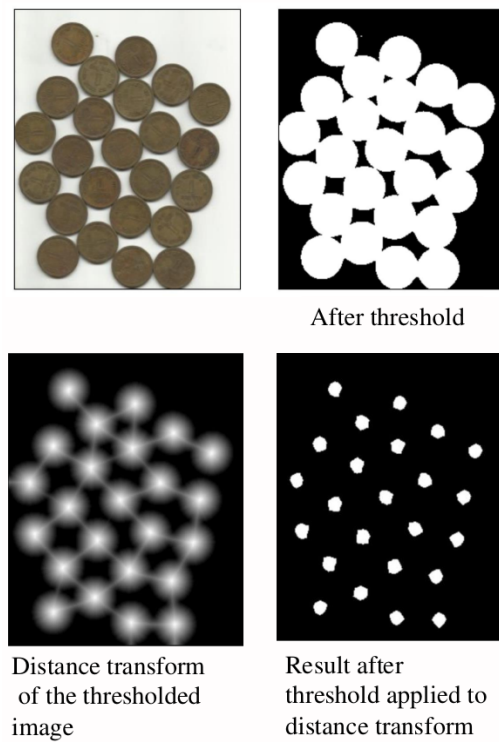

Figure 52: Distance Transform Example

#### 10.4 Skeletonisation

A common approach to **skeletonisation** is to repeatedly thin the image until the result converges.

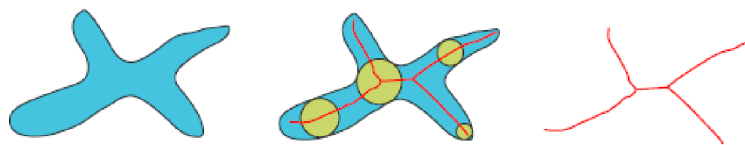

Figure 53: The skeleton of a binary region is defined as the locus of points where the wave fronts of fires set to the boundary meet, or equivalently as the locus of the centres of the maximal balls.

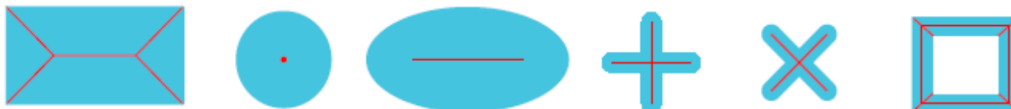

Figure 54: Six different continuous shapes (blue) and their skeletons (red).

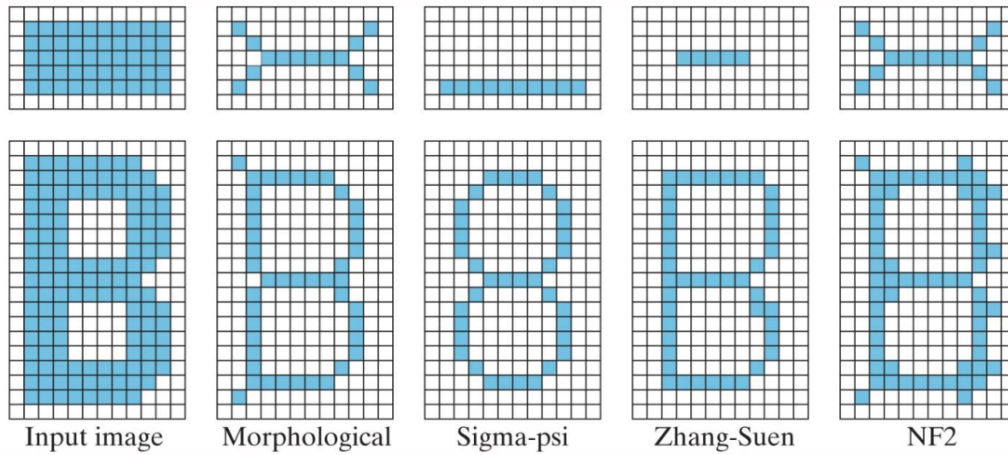

Figure 55: Comparison of the various skeletonisation algorithms on two different binary images.

### 10.5 Region Properties

**Regular moments** are statistical measures calculated from the pixel intensity values of an image that help in understanding the distribution of pixel values and can be used for shape analysis. The  $p^{\text{th}}$  moment is defined as:

$$m_{pq} = \sum_x \sum_y x^p y^q I(x, y)$$

where  $I(x, y)$  is the pixel intensity at co-ordinates  $(x, y)$ .

**Central moments** are similar to regular moments but are computed with respect to the mean of the pixel distribution. They provide a measure of the shape’s properties such as its variance. The  $p^{\text{th}}$  central moment is defined as:

$$\mu_{pq} = \sum_x \sum_y (x - \bar{x})^p (y - \bar{y})^q I(x, y)$$

where  $\bar{x}$  &  $\bar{y}$  are the mean co-ordinates.

The **covariance matrix** is used to describe the distribution of points in a shape. It captures the relationship between the dimensions of the shape and is crucial for understanding the orientation & spread of the shape in the feature space.

$$C = \begin{bmatrix} \mu_{20} & \mu_{11} \\ \mu_{11} & \mu_{02} \end{bmatrix}$$

**Compactness** is defined as:

$$\text{compactness} = \frac{4\pi(\text{area})}{(\text{perimeter})^2}$$



Figure 56: Left: a circle is the most compact shape, with a compactness of 1. Middle: a shape whose compactness is less than 1. Right: the eccentricity of the shape is computed as the eccentricity of the best-fitting ellipse.

The **convex hull** of a region is the shape that results from enveloping the region with a rubber band, which removes all concavities.

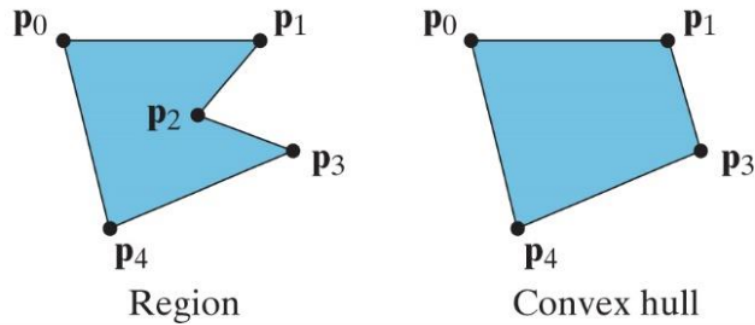

Figure 57: Left: An arbitrarily shaped region in the plane. Right: The convex hull of the region. All vertices in both regions are locally convex except for  $p_2$ .

**Eccentricity** measures the elongatedness of a binary region, i.e., how far it is from being rotationally symmetric around its centroid. To calculate it the eccentricity of a binary region:

1. Find the best/tightest fitting ellipse around the region.
2. Then align this ellipse with the axes.
3. Find the Covariance Matrix of this ellipse:

$$C = P \begin{bmatrix} \lambda_1 & 0 \\ 0 & \lambda_2 \end{bmatrix} P^T$$

This covariance matrix is obtained by using the moments of the binary region encapsulated by the ellipse:

$$C = \frac{1}{\mu_{00}} \begin{bmatrix} \mu_{20} & \mu_{11} \\ \mu_{11} & \mu_{02} \end{bmatrix} = \eta \begin{bmatrix} c & -\frac{b}{2} \\ -\frac{b}{2} & a \end{bmatrix}$$

4. The eccentricity will be a ratio of the eigenvalues of this matrix:

$$\text{eccentricity} = \sqrt{\frac{\lambda_1 - \lambda_2}{\lambda_1}}$$

**Topology** is the study of objects that are preserved under continuous deformations of the objects, e.g., bending, stretching, & compressing but not tearing or sewing. **Homotopy** or rubber sheet deformations is defined to be a deformation which does not change the topology of the object.

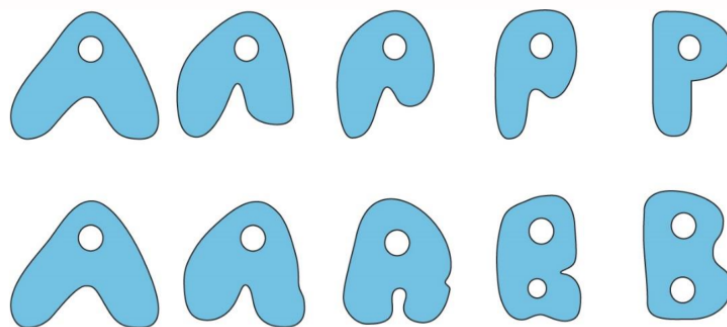

Figure 58: Top: the letters “A” & “P” are related by a homotopy because there is a continuous deformation that relates the two shapes. Bottom: the letters “A” & “B” are not related by a homotopy because there is not a continuous deformation that relates the two shapes. Rather, tearing the region to produce the extra hole is necessary (or sewing the hole in the case of the reverse transformation).

The **Euler number** is a topological invariant characteristic defined by:

$$\begin{aligned} \text{Euler number} &= \text{number of regions} - \text{number of holes} \\ &= \text{number of vertices} - \text{number of edges} + \text{number of faces} \end{aligned}$$

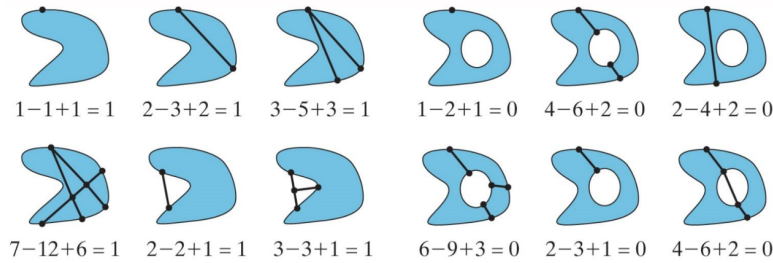

Figure 59: Various tessellations of a region whose Euler number is 1 (left) and 0 (right), showing that the Euler number is not dependent upon the particular tessellation chosen. Under each figure is the number of vertices minus edges plus faces according to the formula for the Euler number. Note that there is implicitly at least one vertex, edges intersect at vertices, & external vertices or edges are not counted.

**Region boundary representations** are classically used in “shape” analysis or recognition. For distinguishing the shape of the boundary, generally we want to transform the sequence into a representation that is invariant to translation, rotation, and/or scale changes, as well as to the starting pixel. The most basic type of **signature** s known as the **centroidal profile** or  **$r$ - $\theta$  curve**. This approach captures the distance  $r$  from the centre of the region as a function of the angle  $\theta$ .

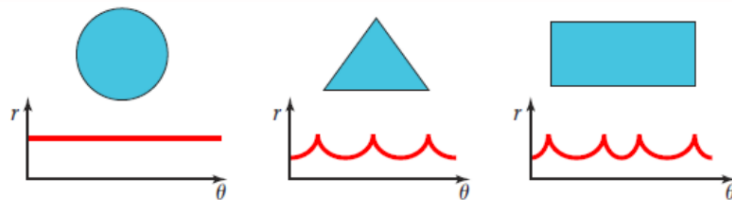

Figure 60: The centroidal profile ( $r$ - $\theta$  plot) of several shapes

## 11 Edge & Feature Detection

### 11.1 Multiresolution Processing

**Multiresolution** refers to analysing the image at multiple resolutions (scales). A  $40 \times 40$  region in the original image will occupy only a  $20 \times 20$  region in the downsampled image, a  $10 \times 10$  region in the twice downsampled image, and so forth. Because each successive image is smaller than its predecessor, stacking the images on top of one another yields the shape of a pyramid called an **image pyramid**. Image pyramids are created by smoothing  $\rightarrow$  downsampling  $\rightarrow$  smoothing  $\rightarrow$  downsampling.

A **Gaussian pyramid** is when the image is smoothed by convolving with a Gaussian kernel.

$$\begin{aligned} I^{(0)}(x, y) &= I(x, y) \\ I^{(i+1)}(x, y) &= \left( I^{(i)}(x, y) \otimes \text{Gauss}_{\sigma^2}(x, y) \right) \downarrow 2 \end{aligned}$$

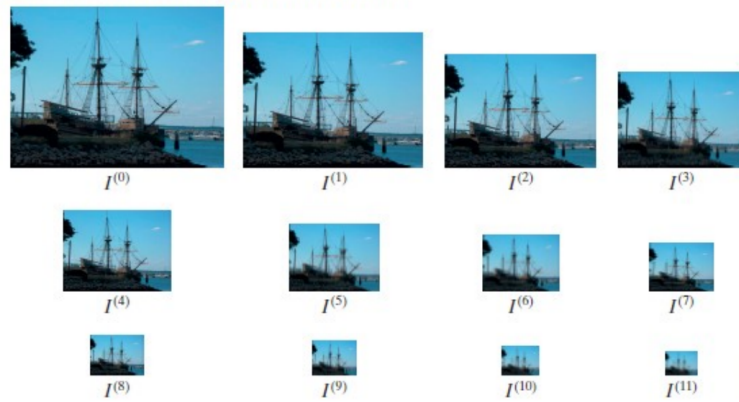

Figure 61: Twelve levels of a Gaussian pyramid, obtained with  $\sigma^2 = \frac{1}{4}(0.5) = 0.125$  and a downsampling factor of  $\sqrt[4]{2}$ . Note that  $I^{(4)}$  is half as large as  $I^{(0)}$  in each direction, and that  $I^{(8)}$  is half as large as  $I^{(4)}$ .

A **Laplacian pyramid** is when the image is smoothed by convolving with several Gaussian kernels of varying variance, then taking their Difference of Gaussian (DoG) to approximate Laplacian of Gaussian (LoG).

$$L^{(i+1)}(x, y) = \left( I^{(0)}(x, y) \otimes \text{LoG}_{(i+1)\sigma^2}(x, y) \right) \downarrow (i + 1)d$$

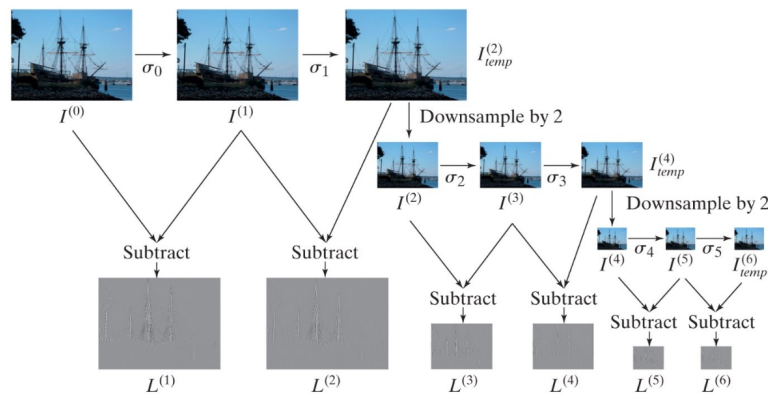

Figure 62: Laplacian pyramid with  $n = 2$  images per octave. The images are successively convolved with a Gaussian, then downsampled at the end of each octave to produce something that closely resembles a Gaussian pyramid. Differences between successive Gaussian-smoothed images yield DoGs, which approximate LoGs. The initial variance is  $\frac{1}{2}(0.5) = 0.25$  and the ratio between successive standard deviations is  $\rho = \sqrt{2}$ .

To construct a series of images at different **scale-spaces**, an image is convolved with varying kernel sizes of Gaussian smoothing kernels of varying size & variance (“scale”). It can be seen as an embedding of the original image into a one-parameter family of Gaussian kernels of increasing variance – being the **continuous parameter**. The image size remains the same and is not down-sampled. It is used in further image analysis techniques such as SIFT Features.



Figure 63: The Gaussian scale space of an image consists of a continuous 3D volume in which each slice is an increasingly blurred version of the original image. Shown here are ten sample images from the scale space.

## 11.2 Edge Detection

**Intensity edges** are pixels in the image where the intensity (or grey level) function changes rapidly. A **step edge** occurs when a light region is adjacent to dark region. A **line edge** occurs when a thing light (or dark) object, such as a wire, is in front of a dark (or light) background. A **roof edge** occurs when the change is not in the lightness itself but rather in the derivative of the lightness. A **ramp edge** occurs when the lightness changes slowly across a region.

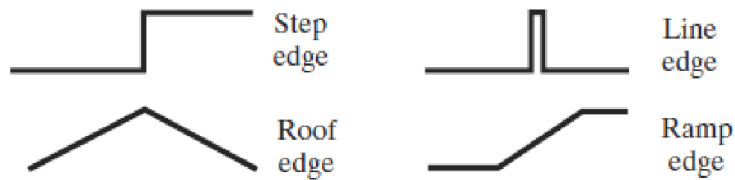

Figure 64: Four types of intensity edges

The **Canny edge detector** is a classic algorithm for detecting intensity edges in a greyscale image that relies on the gradient magnitude. The algorithm involves three steps:

1. First, the gradient of the image is computed, including the magnitude & phase.
2. Second, in **non-maximum suppression**, any pixel is set to zero whose gradient magnitude is not a local maximum in the direction of the gradient.
3. Finally, **edge linking** is performed to discard pixels without much support.

The Canny edge detector is highly regarded for a number of reasons:

- It has a good ability to locate as many edges as possible.
- It is relatively insensitive to noise.
- There will be a minimal distance between its detected edges and the real edges, which is important when you want to measure or classify extracted objects.
- It only gives one response to each edge.

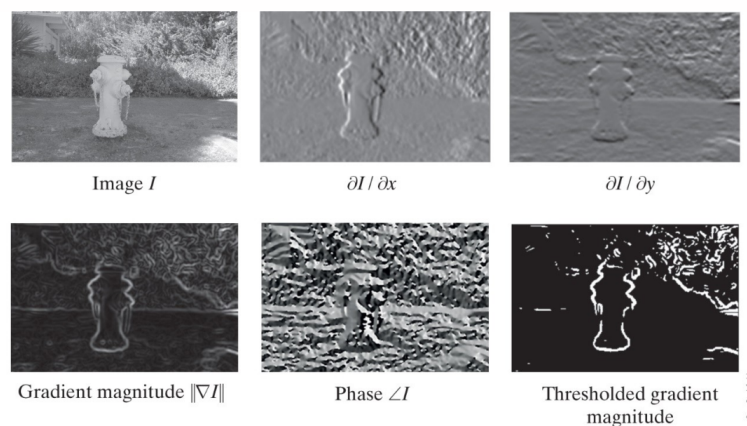

Figure 65: Top: an image and its partial derivatives in the  $x$  &  $y$  directions. Bottom: the gradient magnitude & phase of the image, along with the thresholded gradient magnitude.

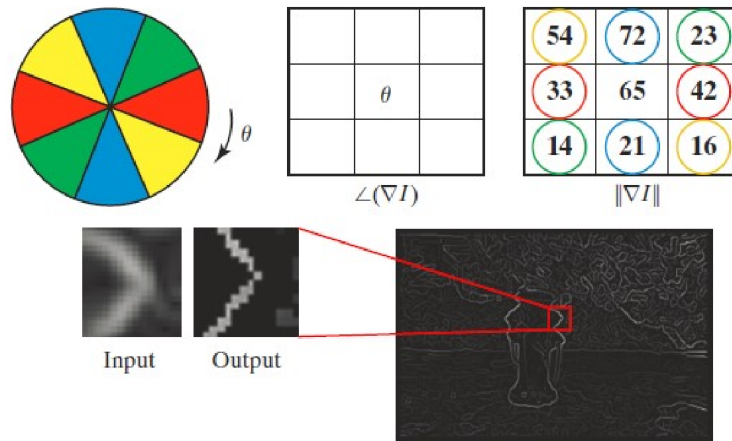

Figure 66: Non-maximum suppression. The gradient direction (or phase)  $\theta$  is quantised into one of four values, shown by the coloured wedges of the circle. The quantised phase governs which of the two neighbours to compare with the pixel. If the gradient magnitude of the pixel is not at least as great as both neighbours, then it is set to zero. This has the effect of thinning the edges, as shown in the inset.



Figure 67: Edge linking with hysteresis, also known as double thresholding or hysteresis thresholding. Thresholding the gradient magnitude with the low threshold produces too many edge pixels (left), while thresholding the high threshold produces too few edge pixels (middle). Edge linking with hysteresis combines the benefits of both (right) to produce the final Canny edge detector output.

### 11.3 Feature Detection

An edge detector finds pixels with large gradient magnitude, whereas a **feature detector** finds pixels where the greyscale values *vary locally in more than one direction*. One of the common places for feature points is at corners. Feature detection is frequently used in motion detection, object tracking, image registration, image stitching, 3D modelling, optical flow, & visual odometry/SLAM (robotics).

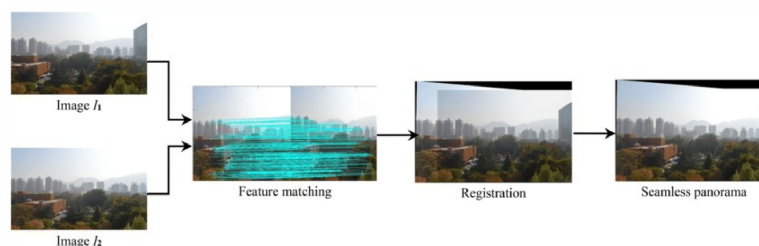

Figure 68: Applications for feature detection include image registration, mosaics, stitching, & panorama generation.

These features are typically hand-crafted as opposed to being discovered by deep learning pipelines. Good features are scale-invariant & rotation invariant.

Recall the **covariance matrix** built from central moments whose eigenvalues were used to find orientation & ec-

centricity of a binary region.

$$\begin{aligned} C_{(2 \times 2)} &= E [(x - \bar{x})(x - \bar{x})^T \rho(x)] \\ &= \frac{1}{\mu_{00}} \begin{bmatrix} \mu_{20} & \mu_{11} \\ \mu_{11} & \mu_{02} \end{bmatrix} \end{aligned}$$

We can then build a **gradient covariance matrix** or **autocorrelation matrix** from image gradients:

$$Z = \sum_{x \in R} w(x) \begin{bmatrix} I_x^2(x) & I_x(x)I_y(x) \\ I_x(x)I_y(x) & I_y^2(x) \end{bmatrix} = \begin{bmatrix} z_x & z_{xy} \\ z_{xy} & z_y \end{bmatrix}$$

Eigenvalues of the gradient covariance matrix indicate how the pixel values are varying in different directions. Eigenvalues are inherently rotationally invariant. If both eigenvalues are large, then the pixel values are varying in different directions. If one eigenvalue is large, it indicates an edge with pixel values that are varying in one direction only.

The **Harris corner detector** finds pixel values with large “corneriness” defines as:

$$\begin{aligned} \text{corneriness} &= \det(Z) - k(\text{trace}(Z))^2 \\ &= z_x z_y - z_{xy}^2 - k(z_x + z_y)^2 \\ &= \lambda_1 \lambda_2 - k(\lambda_1 + \lambda_2)^2 \end{aligned}$$

The **Tomasi-Kanade/Shi-Tomasi detector** finds pixel values with large “corneriness” defined as:

$$\text{corneriness} = \min(\{\lambda_1, \lambda_2\}) = \lambda_2$$

#### 11.4 Feature Descriptors

A **feature descriptor** characterises detected features in a way that can be used for comparison across images. These include: SIFT features, GLOH (Gradient Location & Histogram), HOG (Histogram of Gradients), etc.

## 12 Segmentation & Model Fitting

**Image segmentation** is a bottom-up process that groups pixels in an image based on their low-level properties such as colour or texture.

## 13 Transformation Revision